

Installation Manual

PH2 POWERHALT
AIR INTAKE EMERGENCY SHUT-OFF VALVE



PH2 AIR INTAKE EMERGENCY SHUT-OFF VALVES

APPLICATION

C50201 - 2007½ - 2009 DODGE 6.7L CUMMINS

C50202 - 2010-2012 DODGE 6.7L CUMMINS

800.663.0096

www.powerhalt.com



Thank you for your purchase of a PowerHalt Air Intake Emergency Shut-Off Valve by Pacbrake. Please read the entire manual to ensure you can complete the installation once started.

Should you have any issues during the installation, please call technical support.

A PowerHalt Technical Representative can be reached Monday-Friday 6:00-4:30 (PST) at 800.663.0096

INSTALLATION REQUIREMENTS & RECOMMENDATIONS:

- A 1" clearance is required from the valve to any other components.
- Maximum air temperature at the valve should not exceed 120°C.
- All hoses, adapters, and fittings must be suitable for the vibration of the engine application, and of reinforced type. *If unsure of your vibration requirement, contact Pacbrake.
- Flexible hose gaps should be kept to a minimum and the overall pipe quality and integrity from the shut-off valve to the intake manifold should be confirmed.

NOTE: - Failure to ensure this, may result in hose collapse during valve activation and possible system leaks, preventing engine shutdown

- If an air intake flame trap is used, the valve must be installed upstream of the trap.
- Crankcase breather connections in the intake system between the valve and engine (or in engine intake parts) must be sealed and replaced by an external breather.

Please ensure that you have all the parts listed in this kit **before** you start the installation.

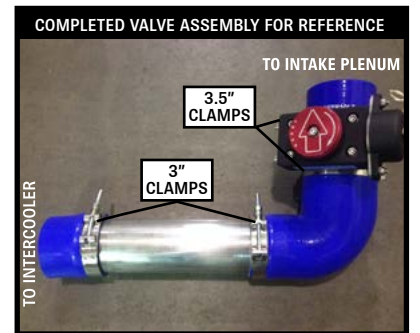
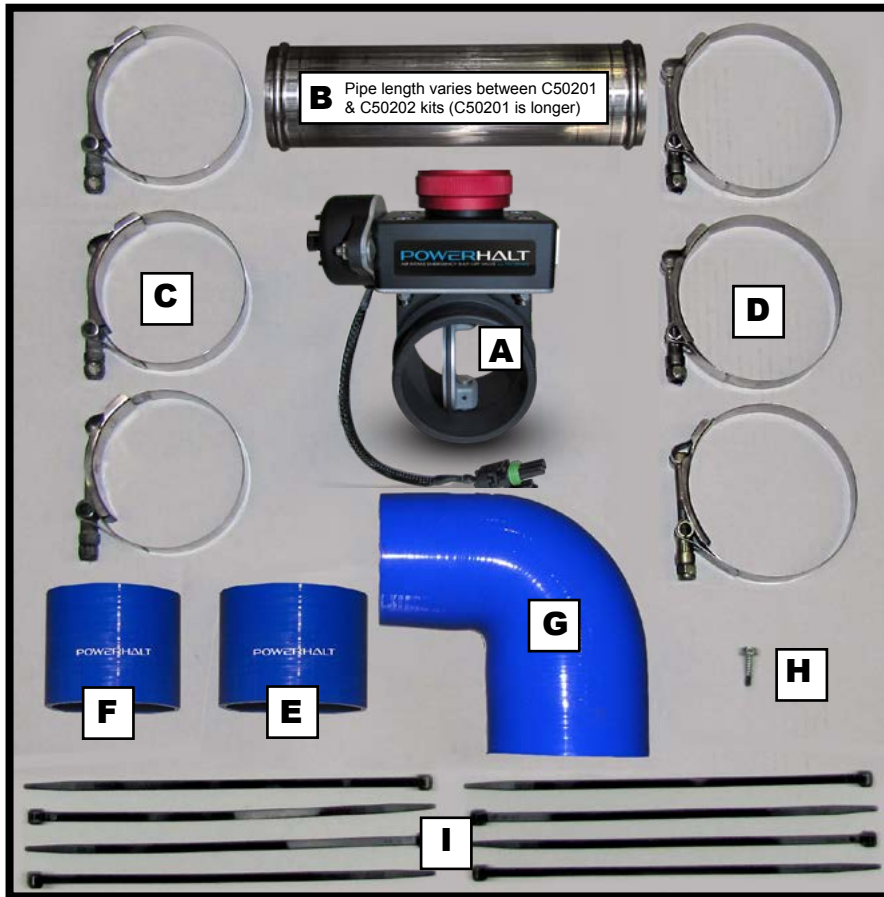

KIT CONTENTS

- A** Shut-Off Valve (1)
- B** Charge Air Cooler (CAC) Pipe (1)
- C** 3" Clamps (3)
- D** 3½" Clamps (3)
- E** 3½" Silicone Hose (1)
- F** 3" Silicone Hose (1)
- G** 3½" - 3" Silicone 90° Hose (1)
- H** Self Tapping Screw (1)
- I** Tie Straps (8)
- J** Harness
- K** Spade Terminal (2)
- L** Washer
- M** Nut
- N** Switch
- O** Switch Identification Plate
- P** Switch Cover
- Q** Relay

REQUIRED TOOLS

- Drill
- 1/2" Unibit
- Ratchet with 7/16", 1/2" & 10mm Deep Sockets
(a 14" extension is ideal)
- Torque wrench capable of 0-80 in-lbs
- Soldering Iron
- Wire Strippers & Crimpers
- Electrical Tape

1 | Open the hood. Disconnect the batteries.

2 | **RELAY INSTALLATION:**

Obtain the provided wiring harness (2A).

Mount the relay receptacle (2B) in a convenient location on the driver's side of the engine compartment, using the self-tapping screw provided.



3 | **SWITCH LOCATION:**

Locate the desired location for the activation switch in your cab.

NOTE:

- Activation switch should be as close to driver's side door as possible to allow for shutdown when standing outside of the vehicle
- Consider the dash construction, as the switch requires a single dash wall for install unless the double wall is modified
- **DO NOT ACTIVATE THE MANUAL SWITCH FOR MORE THAN 10 SECONDS.**
Damage to the solenoid may occur

4 | **SWITCH INSTALLATION:**

Drill a ½" hole in the desired location. Then, install the PowerHalt switch, switch plate, and red switch guard as shown (4A).

Tighten the nut to secure the switch in place.

NOTE: If the dash cannot accept the switch nameplate, use the toggle sticker and install onto the switch cover as shown.

Route the green and black wire to the switch, and cover the wires with the provided loom. Crimp one of the red spade terminals to each wire and connect the wires to the switch (4B), as per the wiring diagram on page 9.

NOTE: Ensure the wiring harness routing is secured with provided tie straps and away from any moving parts or high heat sources.

DASH →

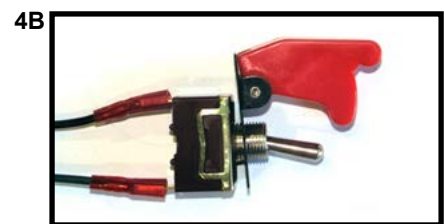

5 | **BATTERY CONNECTION:**

Route the two green and one red fused wire with ring terminals to the driver's side battery location.

Connect the green wires to the negative terminal.

Connect the red fused wire to the positive terminal.

NOTE: Ensure the wiring harness routing is secured with provided tie straps and away from any moving parts or high heat sources.

- 6 VALVE INSTALLATION PREPARATION:**
Remove the driver's side charge air cooler (CAC) pipe and upper silicone hose (6C) using a 7/16" deep well socket with ratchet.

Loosen the clamps as follows:

- intake plenum to silicone hose (6A)
- lower CAC pipe clamp (6B)

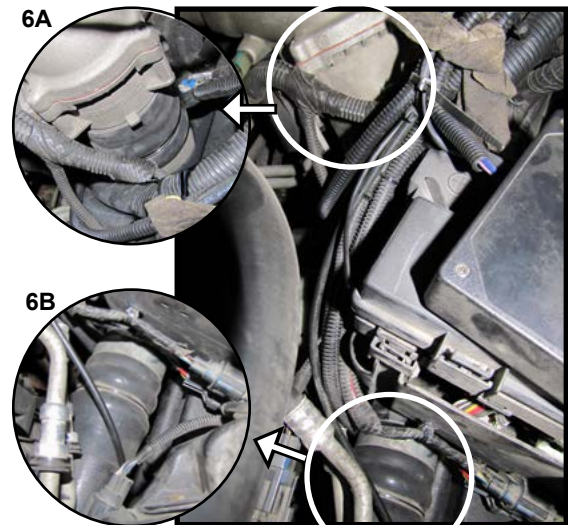

- 7** Using a non-oily cleaner (such as iso-propyl alcohol) and a lint-free cloth, clean the outside of the intercooler and the outside of the intake plenum.



VALVE INSTALLATION:

- 8** Attach the 3.5" silicone hose provided in the kit onto the end of the valve in the direction of the arrow.

Attach the 90 degree elbow on the opposite end of the valve.
(As shown in image #8)

Loosely install the supplied 3½" clamps onto the valve assembly so they can be rotated for clearance during installation.

NOTE: The clamps provided in the kit require a 10mm deep well socket.

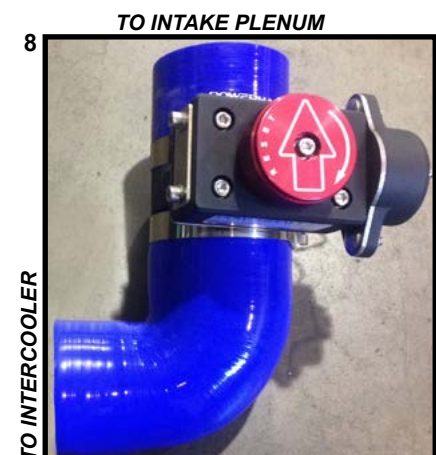

- 9** Attach the provided 3" silicone hose to the end of the CAC pipe. Install a provided 3" clamp and torque to 75 in-lbs (8.5 N•m).

ATTACH THIS END
TO THE INTERCOOLER



- 10** Attach a provided 3" clamp onto the outlet of the intercooler. (not shown)

- 11** Install the CAC pipe with silicone hose to the intercooler, as shown in image #11.

Torque the clamp that was installed in step 10 to 75 in-lbs (8.5 N•m).

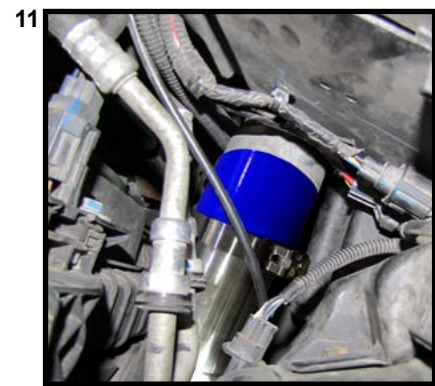

- 12** Attach a 3" clamp onto the exposed end of the CAC pipe.

Place the remaining clamp onto the 3.5" silicone hose going into the intake plenum of the valve assembly (shown with an arrow).

Install the PowerHalt Valve assembly between the CAC pipe and the intake plenum. Note the flow direction arrow on the valve body and the reset knob. It must point in the direction of flow to the intake plenum.

NOTE: All clamps are left loose so that both the clamps and the valve can be rotated into the desired position to clear the engine bay components and to have access to the reset knob.

Once in place, torque all clamps to 75 in-lbs (8.5 N•m).



- 13** Connect the metri pack connector of the harness to the mating connector on the PowerHalt.

NOTE: Ensure the wiring harness routing is secured with provided tie straps and away from any moving parts or high heat sources.

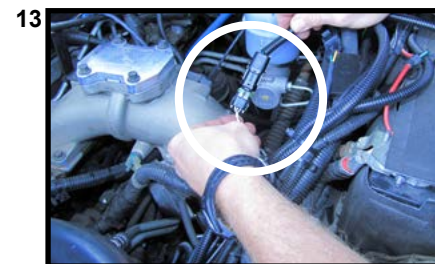

WINDOW DECAL

Install the window decal included in your kit to the lower corner of the inside of your windshield so that it is legible to those on the outside.

POST INSTALLATION TESTING OF YOUR POWERHALT SHUT-OFF VALVE

Once the installation is complete, ensuring all the steps, schematics and recommendations have been followed, it is time to test your system.

1. Activate the manual switch (no engine running).
NOTE: DO NOT ACTIVATE THE MANUAL SWITCH FOR MORE THAN 10 SECONDS. Damage to the solenoid may occur
2. View valve and confirm valve has tripped. The reset knob should be in the tripped position. This will have the line direction on the reset knob facing 90° from air flow direction.



VALVE CLOSED (TRIPPED)



VALVE OPEN (RUN POSITION)

3. Reset the valve.
4. Start the engine and run at low RPM (preferably at idle).
5. Activate the PowerHalt shut-off valve by pushing the manual switch in an upward direction. The engine should stop within a few seconds.
 - If the engine does not shutdown in the specified time please check all intake piping and hoses for leaks between the valve and intake system.
 - If the system is leak-free and your valve still does not shut down the engine, please consult a PowerHalt Service Representative for support.
6. Once the engine stops, wait 30 seconds, then reset the valve by turning the red reset knob clockwise to the open "Run" position with knob arrow in line with air flow direction.

VALVE OPERATION

Prior to running your system you must ensure that the valve is latched (clockwise) into its open position and that the above installation procedure was completed as described. It is recommended that the engine be shipped with the shut-off valve system in its active/open and ready-to-use state.

To carry out the emergency shutdown procedure, the pull cable handle must be pulled as this will shut the valve and stop the engine.

CAUTION: No attempt to restart the engine should happen until the activation information/details are understood and the valve is confirmed to be returned back to the open "Run" position.

NOTE: Please reference your specific operation procedures defined by your organization for additional operation specifics/details. If you require additional recommendations on the steps to operate your shut-off valve, please reference PowerHalt's operation manual based on your application.

VALVE MAINTENANCE

To ensure a trouble-free long life of your PowerHalt shut-off valve a scheduled maintenance procedure is mandatory. It is recommended that you follow the requirements & procedures stated below:

MONTHLY REQUIREMENTS

- Inspect all clamps, pull cables and support brackets to ensure they are in good condition and to the required torque.
- Inspect all wiring & cable runs to ensure there is no corrosion or wear.
- Inspect all hoses to ensure there are no cracks or damage.
- Activate the valve to ensure it is exercised.
See procedure below.

3 MONTH REQUIREMENT (or at oil change interval's whichever comes first)

- Lubricate the PH2, flap O-ring, with Parker® Super O-Lube, Part # SLUBE 884-2, or equivalent.

VALVE ACTIVATION PROCEDURE:

- 1 Run engine at low RPM (preferably at idle).
- 2 Activate the PowerHalt shut-off valve by pulling the cable handle.
The engine should stop within a few seconds.

NOTE:

- If the engine does not shutdown in the specified time, please check all intake piping and hoses for leaks between the valve and the intake system.
 - If the system is leak free and your valve still does not shut down the engine, please consult PowerHalt's service representative for support.
- 3 Once the engine stops, wait 30 seconds, then reset the valve by turning the red reset knob clockwise to the open "Run" position with knob arrow in line with air flow direction.

CAUTION: The #1 failure mode of any valve in the market is seizing due to lack of use. As this is a safety device, it is imperative that you employ safety activation testing at a minimum of once per month.

WIRING SCHEMATIC

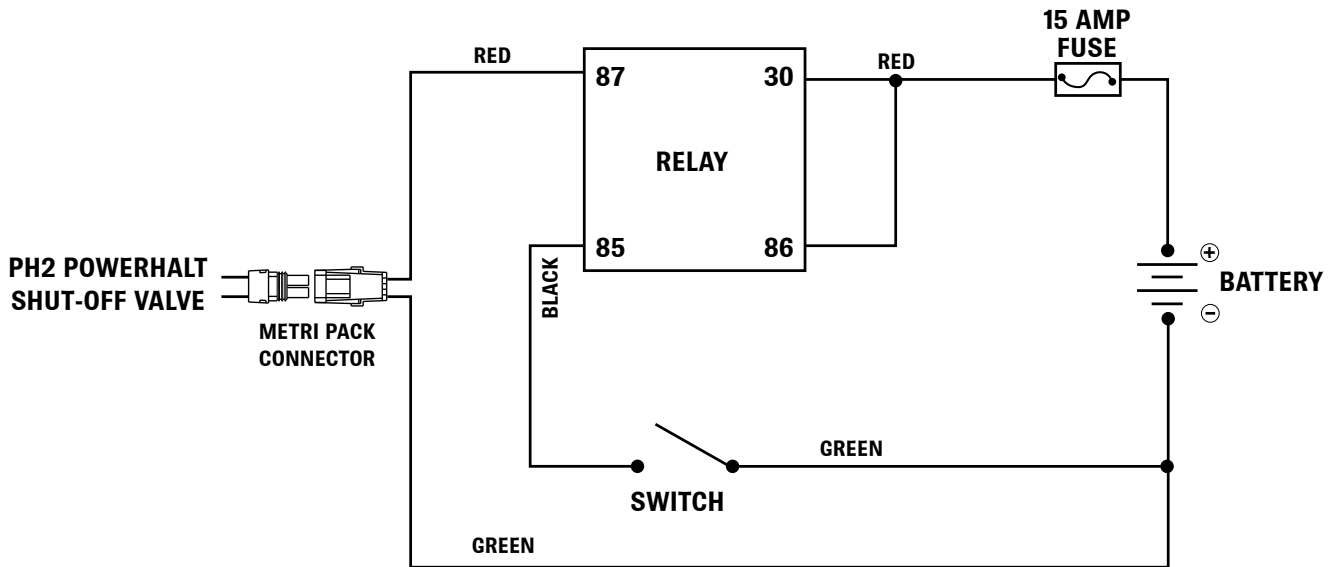

CUSTOMER SERVICE HOURS

MONDAY TO FRIDAY FROM 6:00 AM TO 4:30 PM PST

BUSINESS HOURS OF OPERATION

MONDAY TO FRIDAY FROM 7:30 AM TO 4:00 PM PST

CORPORATE HEADQUARTERS / R&D CENTER

19594 96TH AVENUE
SURREY, BRITISH COLUMBIA



ISO 9001
QMI-SAI Global