

Installation Manual



10187/10195 KIT

10187: Ford F-450 Super Duty (2WD/4WD)*†

10195: Ford F-450 Super Duty (2WD/4WD)*†

*† Including those with 5th wheel/in-bed hitches
NOT FOR USE WITH CHASSIS CAB*



WARNING: This product can expose you to the chemical Hexavalent Chromate, which is known to the State of California to cause cancer and birth defects or other reproductive harm. *For more information go to www.P65Warnings.ca.gov*

KIT LAYOUT

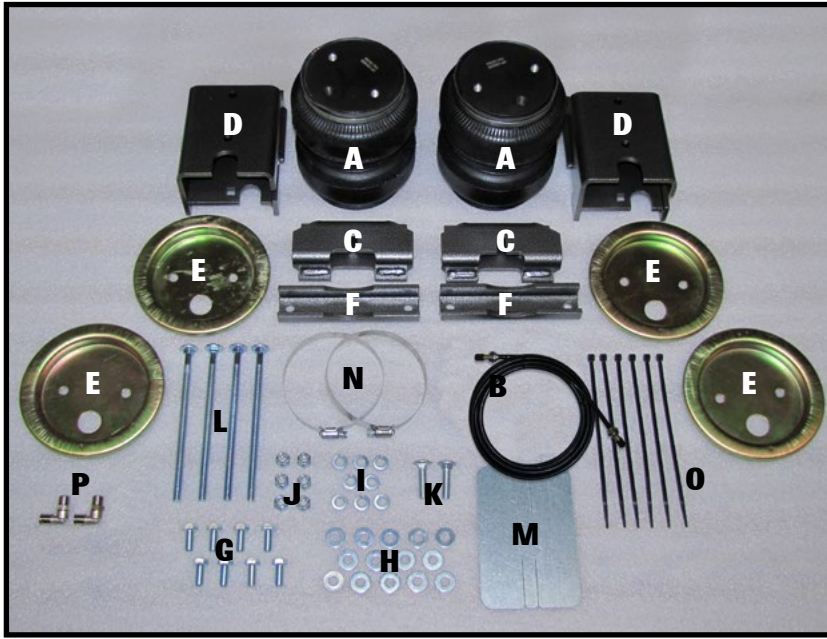

Make sure all the items shown in the photo are provided in your kit before starting the installation.

PLEASE NOTE:

This kit includes “push to connect OR barbed” airline fittings. They require the end of the airline to be round, square and cleanly cut to ensure the internal seal will not leak.

The airline must only be cut with a sharp razor knife or a hose cutter.

KIT CONTENTS

A Air Spring (2)	HP10000
B Air Line/Valve Assembly	HP1344
C Upper Bracket (2)	HP1400
D Lower Bracket (2)	HP1403
E Roll Plate (4)	HP10054
F Axle Clamp Bar (2)	HP1406
G 3/8"-24 x 7/8" Hex Head Cap Screw (8)	HP1002
H 3/8" Flat Washer (14)	C653
I 3/8" Lock Washer (8)	C18007
J 3/8" Nyloc Nut (6)	HP1000
K 3/8"-16 x 1 1/2" Carriage Bolt (2)	HP1408
L 3/8"-16 x 7" Carriage Bolt (4)	HP1409
M Heat Shield (1)	HP0012
N Hose Clamp (2)	HP1001
	HP1377
O Tie Strap (6)	C11618
P 90° Swivel Air Fitting (2)	HP1345

REQUIRED TOOLS

- 7/16", 1/2", 9/16" Open End or Box Wrenches
- 9/16" & 13mm Deep Well Sockets
- Heavy Duty Drill
- 5/16" Drill Bit (very sharp)
- Torque Wrench
- 9/16" Crowsfoot Socket
- Pipe Thread Sealant
- Hose Cutter, Razor Blade or sharp Knife
- Air Compressor/Compressed Air Source
- Hoist or Floor Jack
- Safety Stands
- Safety Glasses
- Spray Bottle with Dish Soap & Water Solution

Thank you and congratulations on the purchase of an air suspension kit. Please read the entire installation manual prior to starting the installation to ensure you can complete the installation once started.

IMPORTANT:

This air suspension kit will not increase the GVWR (Gross Vehicle Weight Rating), as the GVWR is determined by the axle rating. Do not exceed the maximum capacity listed by the vehicle manufacturer.

BEFORE YOU START

1. Ensure the application information is correct for the make, model and year of the vehicle you are installing the kit on.
2. Check the vehicle to see if it is equipped with a 5th wheel hitch. Some 5th wheel hitches require brackets to be mounted in the frame in the same locations as the air spring brackets. (If this is the case, you may need a different air spring kit)
3. We recommend using a good quality anti-seize on all fasteners. This will reduce the chance of corrosion on the fasteners and will help facilitate removal, if required at a later date.

.....

PLEASE NOTE:

Photos shown in this manual are of the passenger's side (unless otherwise noted)

1. RAISE THE REAR AXLE

Park the vehicle on a level surface and remove any unnecessary weight from the vehicle to attain normal ride height. This is important for correct initial air spring setup and adjustment.

Record the vehicle's "normal ride height", which is the distance between the center of the axle and the horizontal wheel well flange. Ensure both sides are the same before raising the vehicle.

Raise the rear axle high enough to remove both rear wheels and attain a comfortable working height. Place a jack stands under each axle (*as shown in the photo*). Lower the floor jack until the vehicle axle is supported by the jack stands.



Ensure the normal ride height measurement recorded earlier remains the same. Adjust if necessary before proceeding.

Once the rear axle is raised correctly, remove the rear wheels.

2. DISASSEMBLY

Remove the stock jounce bumper (see photo), by removing the nut on the inside of the frame by using a 13mm socket



3. UPPER BRACKET ASSEMBLY

I. Roll Plate

Set the roll plate on the top of the air spring, lining up the three holes.

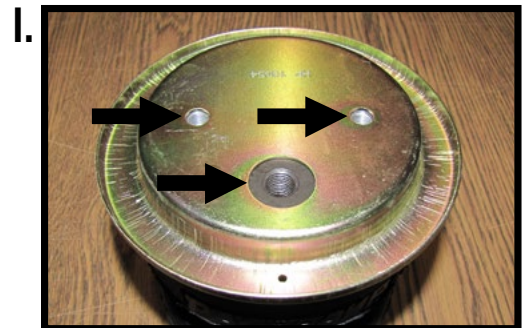

II. Air Line Fitting

Apply thread sealant to the 90° air line fitting and thread into the top of the air spring. It is recommended to install the fitting before the bracket, once the bracket is installed your access to the fitting is limited.

Note: It is also recommended to make sure the fitting is faced parallel to the bracket (as shown in the photo) so it nestles under the frame unobstructed when installing the air line in Step 9.

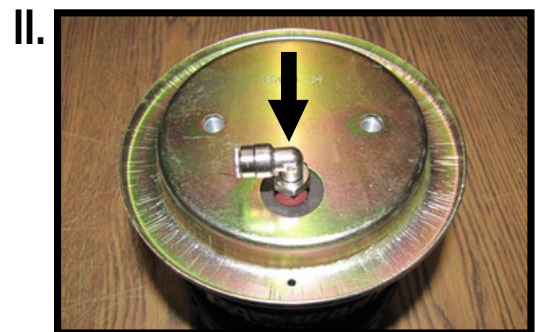

III. Bracket

Loosely attach the upper bracket on top of the air spring roll plate using the 3/8"-24 x 7/8" cap screws, flat and lock washers.

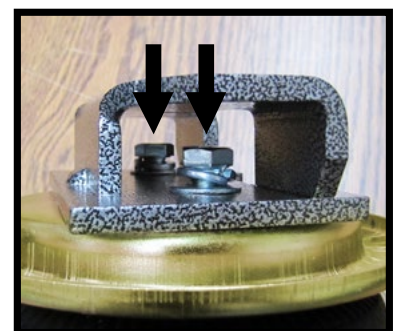

4. ADJUST THE UPPER BRACKET FOR EACH SIDE

The upper bracket must be slid either left or right depending on which side of the vehicle you are mounting the air spring on (see images for details).

With the air line fitting side nearest you (as shown in the photos), slide the bracket to the left for the passenger side air spring & slide to the right for the driver's side air spring.

Using a 9/16" crows foot wrench, torque the cap screws to 20 ft-lbs 27 N•m.

Passenger Side (LEFT)

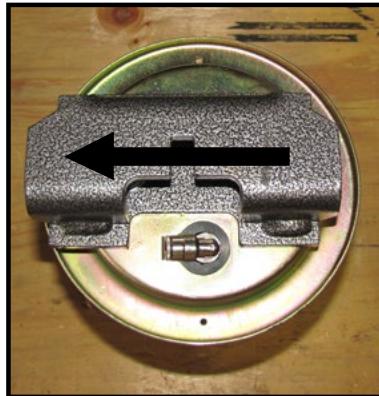

Push bracket all the way to the LEFT for the passenger side.

Driver Side (RIGHT)

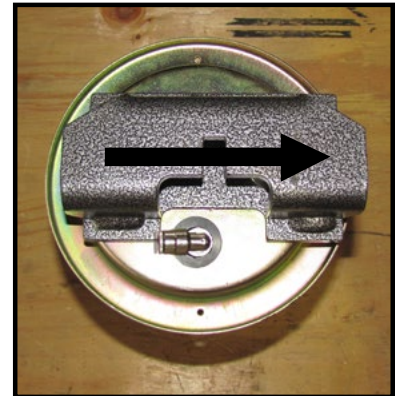

Push bracket all the way to the RIGHT for the driver's side.

5. FASTEN THE UPPER BRACKET TO FRAME

I. Insert a 3/8"-16 x 1 1/2" carriage bolt into the slot in the middle of the upper bracket (as shown in photos with A & B).

Please Note: The direction of the air fittings are pointing to the left for both sides. The passenger side points towards the front of the vehicle so as not to be too close to the exhaust pipe one installed.

II. You will need to hold it in place while installing the air spring assembly into the vehicle.

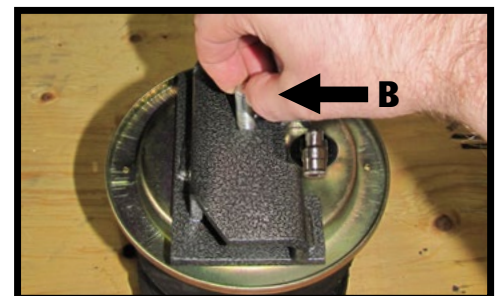
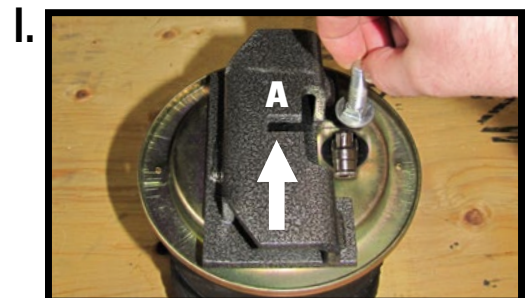

FASTEN THE UPPER BRACKET TO FRAME (cont.)

III. Position the assembly under the frame and insert the carriage bolt through the existing jounce bumper hole in the frame (C). The air fitting will be towards the inboard side of the frame (*as shown*).

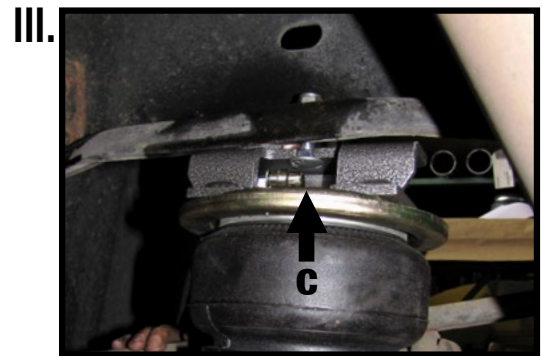

IV. The upper bracket should sit flush with the bottom of the frame.

Fasten the assembly to the frame using the $\frac{3}{8}$ "-16 Nyloc nut and flat washer, torque to 20ft-lbs (27 N•m).

**6. LOWER BRACKET ASSEMBLY****I. Carriage Bolts**

Insert two $\frac{3}{8}$ "-16 x 7" carriage bolts into either side of the lower bracket (A) and set onto the axle under the air spring.

These brackets have slots that correspond with the brake line. Be sure these are facing the rear of the vehicle (*as marked in the photo as **).

DRIVER SIDE NOTE: *The brake line may need to be moved or adjusted slightly in order to install the lower bracket on the driver's side axle.*

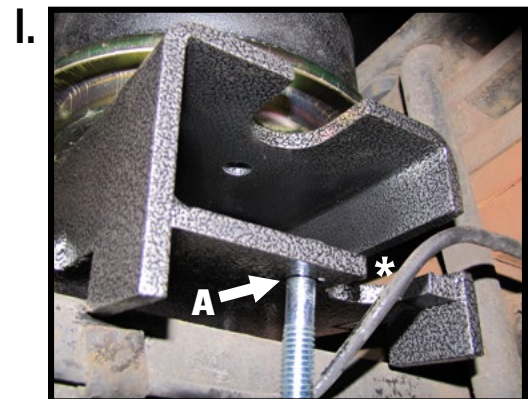
**II. Clamp Bar**

Install the Clamp bar onto the carriage bolts using the $\frac{3}{8}$ " flat washer and nyloc nut.

Leave loose for now.



7. FASTEN LOWER BRACKET

I. Align

With the clamp bar still loose, align the holes in the roll plate/air springs with the holes in the lower bracket.

II. Secure

Attach the lower bracket to the air spring using two $\frac{3}{8}$ "-24 x $\frac{7}{8}$ ".

I.



II.

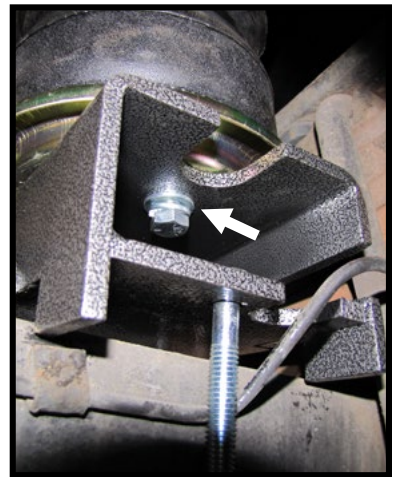

8. ADJUST THE AIR SPRING

Adjust the air spring assembly by moving the lower bracket on the axle tube to ensure the air spring is correctly aligned, as shown in the *Air Spring Alignment* diagram.

Once everything is in the correct alignment, torque the clamp bar nuts to 16 ft-lbs, 21.7 N•m.

Air Spring Alignment

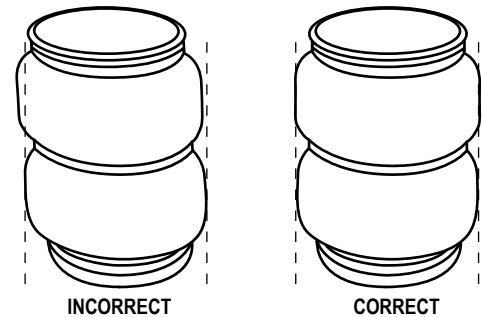

The final assembly should look like the photo shown here.

Repeat steps 5-8 on the driver side.

NOTE FOR DRIVER'S SIDE:

Reattach the brake line (if moved/adjusted in Step 5) and tighten securely once final air spring alignment has been completed.

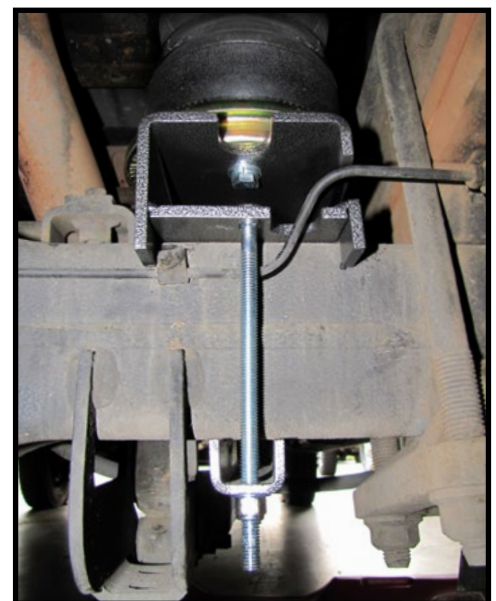

9. INSTALL THE AIR LINE

Provided in the basic air spring kit are two fill valves, the most common place to install them is to replace the license plate fasteners with the fill valves (A). Alternatively, two holes can be drilled in a convenient location. Install one airline provided, route the nylon hose to an air spring fitting, cut the hose and connect to the air spring fitting. Repeat with the other fill valve. Secure airlines with the tie-straps provided away from moving items and heat sources.

If an in cab inflation kit is being installed, follow the instructions provided with it.

NOTE: This kit contains push to connect fittings, using scissors or wire cutters to cut the nylon airline will distort the line and cause the connection to leak. **THE AIRLINE MUST BE CUT OFF SQUARELY WITH A SHARP RAZOR KNIFE.** Moisten the end of the airline prior to inserting it into the fitting and push it in until it stops.

After the air line is cut, insert one end into the air line fitting, as shown in (B), and the other into the fill valve. Moisten the end of the air line with liquid soap prior to inserting it, and then push it in until it stops

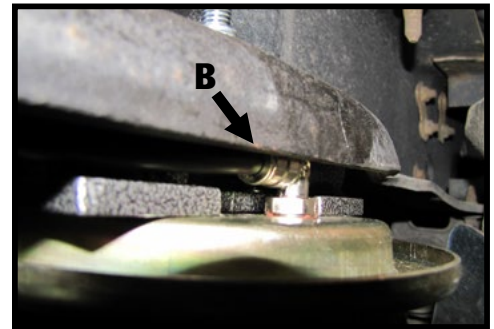
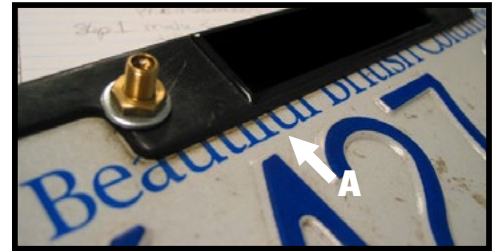

10. INSTALL THE HEAT SHIELD

Bend the two center tabs of the heat shield and attach it to the exhaust pipe with the supplied gear clamps as show.



11. DO A LEAK CHECK

Inflate both the air springs to 90 PSI, then use a dish soap and water mixture on all air line connections to detect any air leaks. Repair as necessary and retest.

Inflate the air springs to a predetermined value, and on the following day recheck the pressure. If one or both the air springs have lost pressure, a leak is present. The leak must be repaired, and then retested until no leaks exist.



12. AFTER THE INSTALLATION IS COMPLETED, PLEASE REMEMBER:

Install the wheels, torquing the fasteners to the manufacturer’s specifications.

Re-torque all the fasteners after the first 500 miles of driving.

For safe and proper operation, never operate the vehicle under the minimum of 10 PSI or over the maximum of 100 PSI. Staying within the pressure limit will ensure maximum air spring life. Failure in doing so may result in a void warranty (see *Note* below).



Thank you again, and congratulations on the installation of the air suspension kit.

OPTIONAL ACCESSORIES

Optional dual needle air gauges are available to monitor pressure in each spring from vehicle cab, as well as a full line of air compressors, air tanks, and solenoids built to work with and control your air spring system.

OPERATING YOUR VEHICLE WITH AIR SUSPENSION

Air springs have minimum and maximum pressure requirements. Never operate your vehicle with less than 10 psi in air spring and never inflate air springs over 100 psi. Damage to air springs will result.

Check air pressure in air springs daily for first couple of days to ensure a leak has not developed. Air springs are designed to maintain the vehicles stock ride height with a load. Do not use the air springs as a means to lift vehicle with no load. This will result in a harsh ride.

SERVICING YOUR VEHICLE WITH AIR SUSPENSION

When lifting the vehicle with a floor jack or hoist on the frame, never allow the air spring to limit the travel of the axle. Try to always jack the vehicle on the axle. Suspending the axle with the air spring limiting the axle travel will damage the air spring and void the air spring warranty.

WARRANTY

To be eligible for warranty, the owner must submit their warranty card or register online within 30 days of the purchase date.

NOTE: The owner’s warranty will be void if air springs are run with less than the minimum of 10 psi.

