

# Installation Manual

**PH2 POWERHALT**  
AIR INTAKE EMERGENCY SHUT-OFF VALVES by PACBRAKE



**PH2 C50210A AIR INTAKE SHUT-OFF VALVE**

**WITH POWERGUARD SMART OVERSPEED LIMITER**

2011 - 2016 GMC/CHEVY DURAMAX

800.663.0096 [www.powerhalt.com](http://www.powerhalt.com)



Thank you for your purchase of a PowerHalt Air Intake Emergency Shut-Off Valve by Pacbrake. Please read the entire manual to ensure you can complete the installation once started.

Should you have any issues during the installation, please call technical support.

**A PowerHalt Technical Representative can be reached Monday-Friday 6:00-4:30 (PST) at 800.663.0096**

---

#### INSTALLATION REQUIREMENTS & RECOMMENDATIONS:

- A 1" clearance is required from the valve to any other components.
- Maximum air temperature at the valve should not exceed 150°C.
- All hoses, adapters, and fittings must be suitable for the vibration of the engine application, and of reinforced type. \*If unsure of your vibration requirement, contact Pacbrake.
- Flexible hose gaps should be kept to a minimum and the overall pipe quality and integrity from the shut-off valve to the intake manifold should be confirmed.

NOTE: - Failure to ensure this may result in hose collapse during valve activation and possible system leaks, preventing engine shutdown

- If an air intake flame trap is used, the valve must be installed upstream of the trap.
- Crankcase breather connections in the intake system between the valve and engine (or in engine intake parts) must be sealed and replaced by an external breather.

Please ensure that you have all the parts listed in this kit **before** you start the installation.

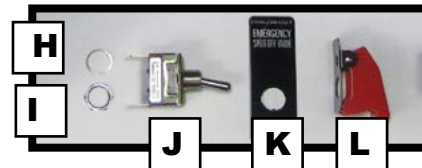
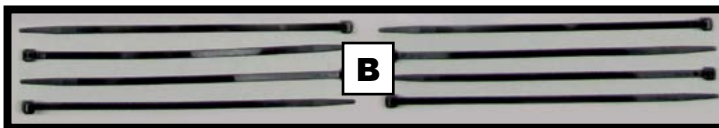
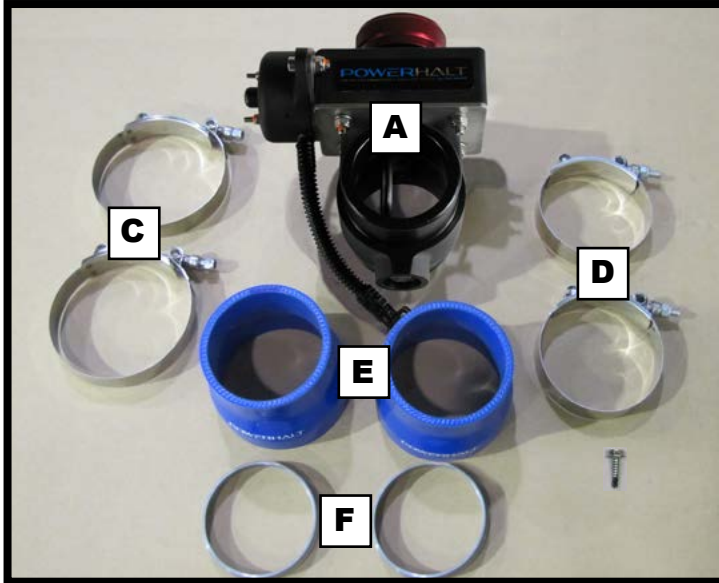

## KIT CONTENTS

- A** Shut-Off Valve (1)
- B** Tie Straps
- C** 2½ Clamps (2)
- D** 2¾ Clamps (2)
- E** 2¾" - 2½ Silicone Reducer (2)
- F** Bead Ring (2)
- G** Wiring Harness
- H** Washer
- I** Nut
- J** Switch
- K** Switch Identification Plate
- L** Switch Cover
- M** Bracket
- N** M-10 x 1.5 Fastner
- O** Gear Clamp
- P** Flat Washer M 10
- Q** PowerGuard Controller
- R** Butt Connector

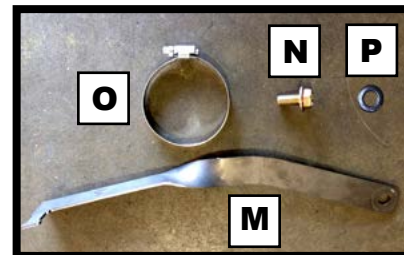

## REQUIRED TOOLS

- Drill Motor
- ½" Unibit
- Ratchet with 7/16", ½" and 10 and 15mm DeepSockets  
(30" Extra Length Extension is ideal)
- Wire Strippers & Crimpers
- Electrical Tape
- Cut-Off Saw / Angle Grinder
- Welder
- Flat Blade Screwdriver

- 1 | Open the hood.  
Disconnect both batteries

**PASSENGER SIDE**



**DRIVER'S SIDE**



- 2 | **CONTROLLER, SWITCH & WIRING HARNESS INSTALLATION:**

Use self tapping screws or tie straps to secure the PowerGuard controller to the desired location. Ensure the box is accessible, as it will need to be used for the set-up procedure.

*CAUTION: Please ensure the PowerGuard controller box is mounted in a location where it is not exposed to high pressure water contact or where it can reach ambient temperatures that exceed 80°C.*



- 3 | Route the white wire of the Pacbrake harness to the Crankshaft Position Sensor wire, located in pin 61 (White wire with Black trace) of the X3 Connector of the ECM J3 location, Located on the driver's side of the engine.

Splice this wire with the white wire of the Pacbrake harness in a convenient location, using the supplied heat shrinkable butt connector.

Once crimped, heat the connector to provide a water tight seal.

Secure all wires away from moving parts and heat sources using the supplied tie straps.

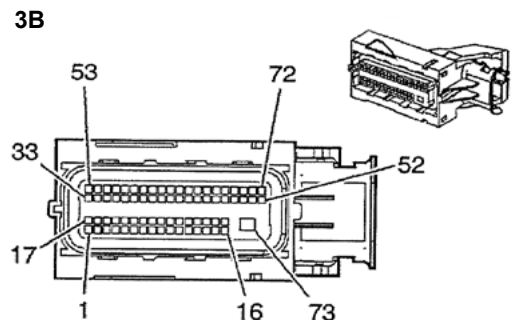
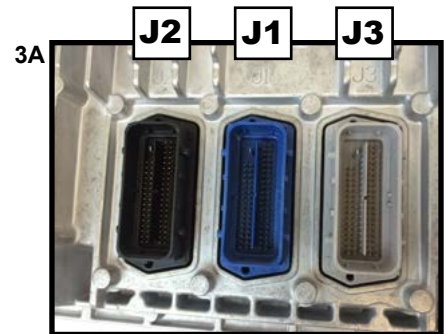

3 CONTINUED:

ENGINE CONTROL MODULE (ECM) X3 (LGH or LML)			
Pin	Wire Color	Circuit No.	Function
58	0.5 OG/BK	3656	EGR Cooler Bypass Motor Open Control (LML)
59	0.5 L-GN	3655	EGR Cooler Bypass Motor Open Control (LML)
60	0.5 GY/BK	6272	Low Reference
61	0.5 WH/BK	6271	CKP Sensor Signal (Crankshaft Position Sensor)
62	0.5 D-GN	485	Throttle Position Sensor Signal 1
63	---	---	Not Available
64	0.5 D-GN/WH	6142	Power Take Off Engine Shutdown Signal (PTO)

4 SWITCH LOCATION:

Locate a desired location for the activation switch in your cab.

NOTE:

- Activation switch should be as close to driver's side door as possible to allow for shutdown when standing outside of the vehicle
- Consider the dash construction, as the switch requires a single dash wall for install unless the double wall is modified
- **DO NOT ACTIVATE THE MANUAL SWITCH FOR MORE THAN 10 SECONDS.**  
**Damage to the solenoid may occur**



5 SWITCH INSTALLATION:

Drill a 1/2" hole in the desired location. Then install the PowerHalt switch, switch plate, and red switch guard as shown (5A).

Tighten the nut to secure the switch in place.

*NOTE: If the dash cannot accept the switch nameplate, use the toggle sticker and install onto the switch cover as shown.*

Route the green and black wire to the switch, and cover the wires with the provided loom. Crimp one of the red spade terminals to each wire and connect the wires to the switch (5B), as per the wiring diagram on page 14.

*NOTE: Ensure the wiring harness routing is secured with provided tie straps and away from any moving parts or high heat sources.*

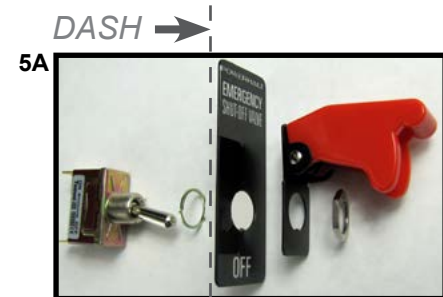

- 6** | Route the red and red/white stripe wires of the harness to the switch location. Cut to length and crimp on the spade terminals then connect it to the switch.

*NOTE: Ensure the wiring harness routing is secured with provided tie straps and away from any moving parts or high heat sources.*

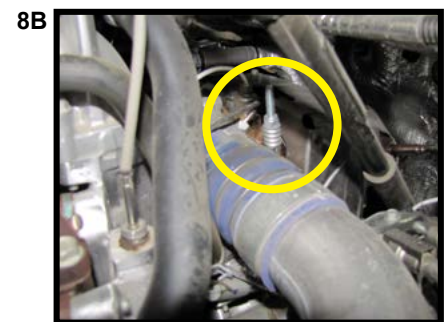

- 7** | **BATTERY CONNECTION:**  
Route the two green and one red fused wire with ring terminals to the driver's side battery location.

Connect the green wires to the negative terminal.

Connect the red fused wire to the positive terminal.

*NOTE: Ensure the wiring harness routing is secured with provided tie straps and away from any moving parts or high heat sources.*

*Extra Length 30" Extension*

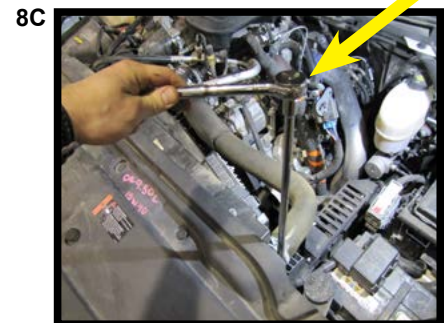

- 8** | **VALVE INSTALLATION PREPARATION:**  
Remove the driver's side charge air cooler (CAC) pipe (8A) using  $\frac{7}{16}$ " deep well socket with ratchet to loosen the clamp (pic 8B - 8D).

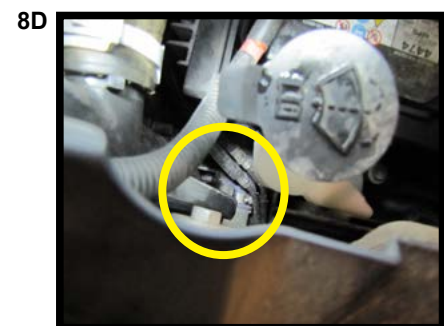

**9** Maneuver the pipe out of the truck.

Once the pipe is removed, mark each end of the pipe with the letters 'A' and 'B'. 'A' will be your turbo side, and 'B' will be the CAC side. See picture 9B for reference.

The first cut can be made at 5 1/2" from the factory pipe benders grip start on the CAC side. NOTE: the grip start is approximately 3" from the end of the silicone boot, as per image 9A.

Then make a second cut from the grip start at 1 3/4".

**NOTE: Ensure all the cuts are straight.**

**Cut pipes should look like this:**

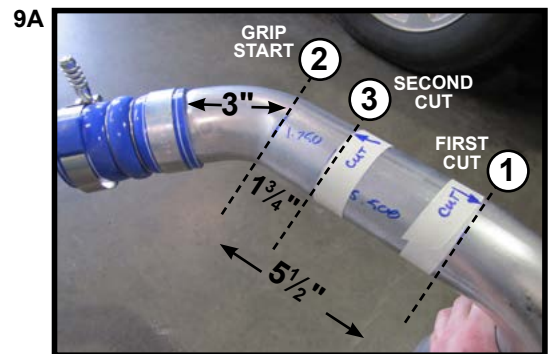

**10** Notch the ends of each cut pipe in 3 equal places with an angle grinder or cut off saw, as shown in pic 10A.

Attach the machined bead ring to the end of each cut pipe and tack weld into place by welding in the newly created notch (pics 10B and 10C). The ring may need to be cut to fit securely on the pipe before welding (see pics 10C and 10D).

Make sure that full weld penetration is achieved.

Then file smooth any burrs or snags from the welding.

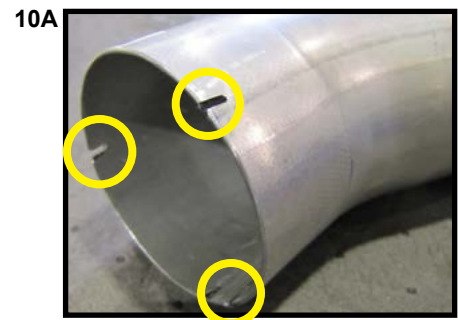

- 11** | Attach the silicone reducers to the valve and install the two 2 ¾" clamps. Torque to 75 in-lbs (8.5 N•m).



- 12** | Attach the turbo side of the pipe (A) onto the turbo outlet first. Leaving the clamp loose (pic 12A). Reinstall the CAC section of the pipe (B) and tighten the factory clamp (pic 12B).

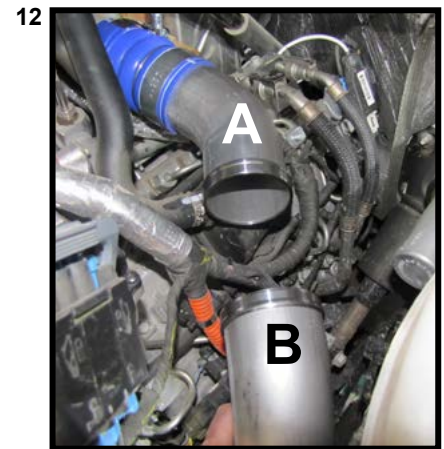



- 13** Loosely install both 2 ½" band clamps over the silicone reducer ends. Install the PowerHalt, making note of the flow direction (see pic 13A, 13B and 14). The arrow should be pointing away from the turbo and towards the intercooler.

**NOTE:** The arrow is shown on the body of the valve, on the opposite side of the electric solenoid actuator.

Tighten the band clamps hand tight.

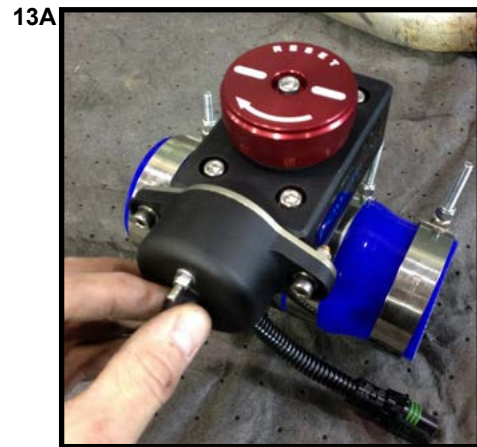

- 14** Rotate the pipes and the PowerHalt valve into position so that they are not rubbing or touching any other engine components. The reset knob should be somewhat horizontal with the top of the engine.

Torque all clamps to 75 in-lbs (8.5 N.m).



- 15** | **SUPPORT BRACKET INSTALL:**  
Locate the two threaded mounting boss's below the A/C compressor on the driver's side of the truck.  
(see pic 15).



- 16** | Install the support bracket to the forward boss with leg end facing towards the CAC pipe. Loosely install the supplied M-10 x 1.5 Fastner and flat washer (pic 16B).

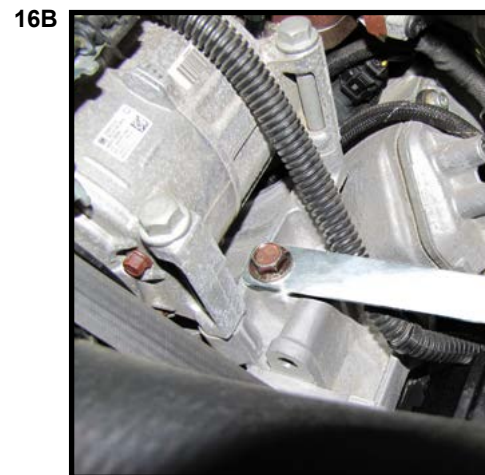

- 17** | Undo the gear clamp provided in the kit and place it over the CAC pipe. Attach the gear clamp around the support bracket and tighten securely as shown (see pic 17A, 17B, 17C).

**Note:** *The bracket is flexible enough that it can be bent slightly by hand to properly align with the CAC pipe.*

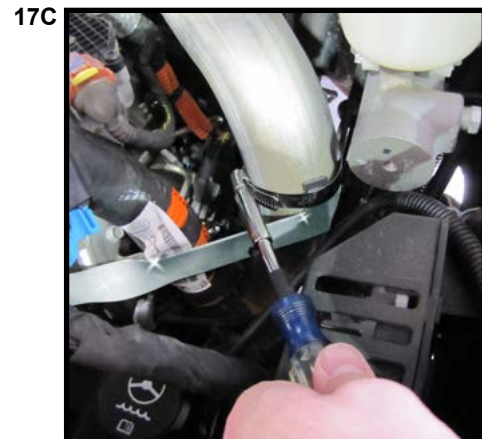
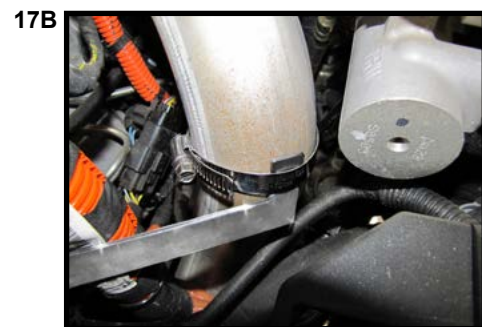
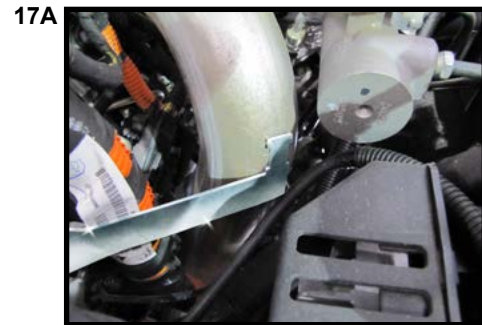

- 18** | Torque the M-10 x 1.5 Fastner to 40 ft-lbs (54 N.m).

- 19** | Connect the metri pack connector of the harness to the mating connector on the PowerHalt.

**Note:** *Ensure the wiring harness routing is secured with provided tie straps and away from any moving parts or high heat sources*

- 20** | Reconnect the batteries.



## POWERGUARD LEGACY CONTROLLER

**NOTE:** The PowerGuard controller For PH2 kits has been updated with new technology. If you have a kit with our Legacy Controller (Serial # CPG100339 & before) see the addendum for the proper set-up procedure.

[Pacbrake.com/Legacy](http://Pacbrake.com/Legacy)

**CURRENT CONTROLLER**  
(AFTER SERIAL # CPG100339)

**LEGACY CONTROLLER**  
(SERIAL # CPG100339 & BEFORE)

## SETUP PROCEDURE

The PowerHalt is a smart controller that detects diesel engine runaway and immediately stops the engine by triggering the emergency air shut-off valve. The unit has the following states:

**UNPROGRAMMED STATE:** When you first purchase your kit, the controller's red and green lights will flash in an alternating order to indicate there is no emergency engine shut-off speed programmed.

**PROGRAMMED STATE:** If an emergency engine shutdown speed has been programmed to the controller's memory, the controller unit will act in the following way:

- **Engine off:** no lights flashing
- **Engine running:** green light flashes every 5 seconds indicating the system is working as intended
- **Valve actuated (manually or automatically):** the emergency shut-off has occurred and the red light on the controller turns on for 5 seconds

### SETTING THE EMERGENCY ENGINE SHUT-OFF SPEED

If the controller has no emergency engine shutoff speed programmed, setup is required for the emergency shut-off system to function. The controller uses a setup engine speed and adds a user defined overspeed margin to program the emergency engine shut-off speed.

**IMPORTANT:** Please consult your engine manufacturer and the relevant safety operating procedures to determine the emergency engine shut-off speed prior to proceeding.

1. With the engine idling, hold down the SET and TEST buttons simultaneously until both lights begin to flash (approximately 5 seconds), then release the buttons
2. Press and release the SET button on the controller to begin monitoring engine speed – the red light will flash rapidly to confirm the engine speed is being monitored
3. Bring the engine to your desired setup engine speed **GRADUALLY**, then return engine to idle.  
**WARNING:** The controller is monitoring for the peak RPM while the engine is brought up to speed – do not exceed your target RPM or you will need to restart this procedure
4. Press the SET button: 1 time to add 10% to the setup engine speed for the emergency engine shut-off speed, 2 times for 20%, 3 times for 30% or 4 times for 100%
5. When the data is saved successfully, the red light will confirm your input by blinking the same number of times the SET button was pressed. If no engine speed is detected, the controller will exit the setup and erase any saved engine speed from the memory
6. Check the controller to verify that programming was successful by confirming that the green light blinks every 5 seconds while the engine is running
7. Document your emergency shut-off speed for future reference

SETUP RPM	PRESS "SET" BUTTON	OVERSPEED MARGIN		EMERGENCY ENGINE SHUTOFF SPEED (SETUP RPM) + (OVERSPEED MARGIN)
		%	RPM	
1800	1 time	10	$1800 \times 0.10 = \mathbf{180}$	$1800 + 180 = \mathbf{1980}$
1800	2 times	20	$1800 \times 0.20 = \mathbf{360}$	$1800 + 360 = \mathbf{2160}$
1800	3 times	30	$1800 \times 0.30 = \mathbf{540}$	$1800 + 540 = \mathbf{2340}$
1800	4 times	100	$1800 \times 1.00 = \mathbf{1800}$	$1800 + 1800 = \mathbf{3600}$

### TEST MODE

The test mode ensures that the system's automatic function is working as intended.

1. Hold the SET and TEST buttons simultaneously until both lights begin to flash (approximately 5 seconds), then release both buttons
2. Press then release the TEST button on the controller, the green light will start flashing rapidly and the red light will turn off
3. Raise the engine speed to HALF of the emergency engine shut-off speed
4. The emergency shut-off valve will actuate to shut down the engine
5. The green light will continue flashing and the red light will illuminate for 5 seconds before returning to Programmed State

**NOTE:** If the valve activated but the engine failed to shut down, check for leaks in the piping and consult a PowerHalt representative.

### ERASING THE EXISTING EMERGENCY ENGINE SHUTOFF SPEED

1. Hold both SET and TEST buttons simultaneously until both lights begin to flash (approximately 5 seconds) before releasing
2. Press and hold the SET button until the red and green lights begin flashing in an alternating order, indicating that memory has been cleared
3. Repeat SETUP PROCEDURES to program a new emergency engine shut-off speed

### SYSTEM FUNCTION FLOW CHART

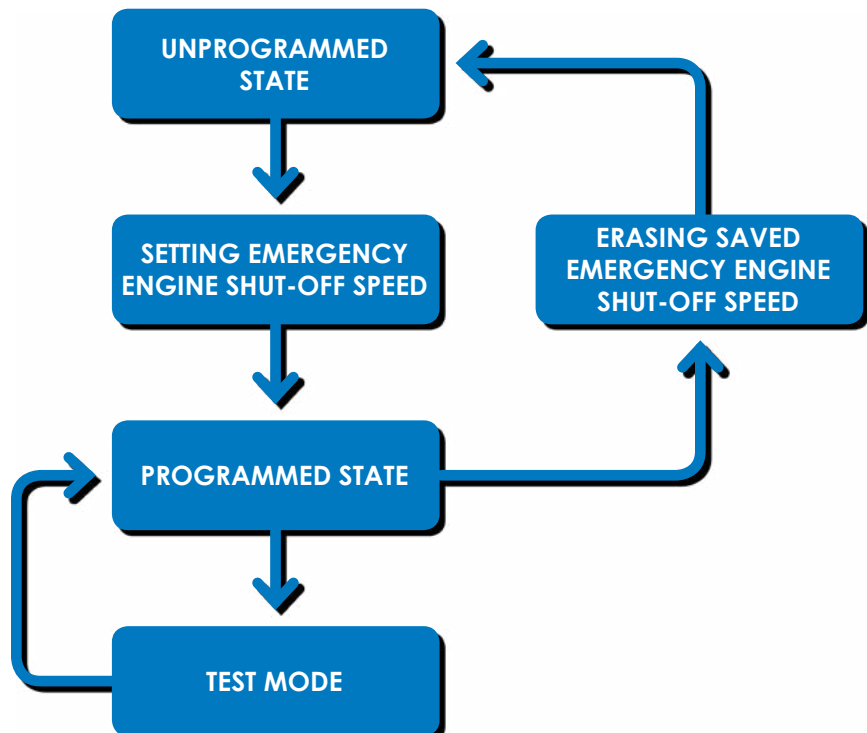

## WINDOW DECAL

Install the window decal included in your kit to the lower corner of the inside of your windshield so that it is legible to those on the outside.

## POST INSTALLATION TESTING OF YOUR POWERHALT SHUT-OFF VALVE

Once the installation is complete, ensuring all the steps, schematics and recommendations have been followed, it is time to test your system.

1. Activate the manual switch (no engine running).  
**NOTE: DO NOT ACTIVATE THE MANUAL SWITCH FOR MORE THAN 10 SECONDS. Damage to the solenoid may occur**
2. View valve and confirm valve has tripped. The reset knob should be in the tripped position. This will have the line direction on the reset knob facing 90° from air flow direction.



VALVE CLOSED (TRIPPED)



VALVE OPEN (RUN POSITION)

3. Reset the valve.
4. Start the engine and run at low RPM (preferably at idle).
5. Activate the PowerHalt shut-off valve by pushing the manual switch in an upward direction. The engine should stop within a few seconds.
  - If the engine does not shutdown in the specified time please check all intake piping and hoses for leaks between the valve and intake system.
  - If the system is leak-free and your valve still does not shut down the engine, please consult a PowerHalt Service Representative for support.
6. Once the engine stops, wait 30 seconds, then reset the valve by turning the red reset knob clockwise to the open "Run" position with knob arrow in line with air flow direction.

## VALVE OPERATION

Prior to running your system you must ensure that the valve is latched (clockwise) into its open position and that the above installation procedure was completed as described. It is recommended that the engine be shipped with the shut-off valve system in its active/open and ready-to-use state.

To carry out the emergency shutdown procedure, the pull cable handle must be pulled as this will shut the valve and stop the engine.

**CAUTION:** No attempt to restart the engine should happen until the activation information/details are understood and the valve is confirmed to be returned back to the open "Run" position.

**NOTE:** Please reference your specific operation procedures defined by your organization for additional operation specifics/details. If you require additional recommendations on the steps to operate your shut-off valve, please reference PowerHalt's operation manual based on your application.

## VALVE MAINTENANCE

To ensure a trouble-free long life of your PowerHalt shut-off valve a scheduled maintenance procedure is mandatory. It is recommended that you follow the requirements & procedures stated below:

### MONTHLY REQUIREMENTS

- Inspect all clamps, pull cables and support brackets to ensure they are in good condition and to the required torque.
- Inspect all wiring & cable runs to ensure there is no corrosion or wear.
- Inspect all hoses to ensure there are no cracks or damage.
- Activate the valve to ensure it is exercised.  
See procedure below.

### 3 MONTH REQUIREMENT (or at oil change interval's whichever comes first)

- Lubricate the PH2, flap O-ring, with Parker® Super O-Lube, Part # SLUBE 884-2, or equivalent.

### VALVE ACTIVATION PROCEDURE:

- 1 Run engine at low RPM (preferably at idle).
- 2 Activate the PowerHalt shut-off valve by pulling the cable handle.  
The engine should stop within a few seconds.

#### NOTE:

- If the engine does not shutdown in the specified time, please check all intake piping and hoses for leaks between the valve and the intake system.
  - If the system is leak free and your valve still does not shut down the engine, please consult PowerHalt's service representative for support.
- 3 Once the engine stops, wait 30 seconds, then reset the valve by turning the red reset knob clockwise to the open "Run" position with knob arrow in line with air flow direction.

**CAUTION:** The #1 failure mode of any valve in the market is seizing due to lack of use. As this is a safety device, it is imperative that you employ safety activation testing at a minimum of once per month.

**WIRING SCHEMATIC**

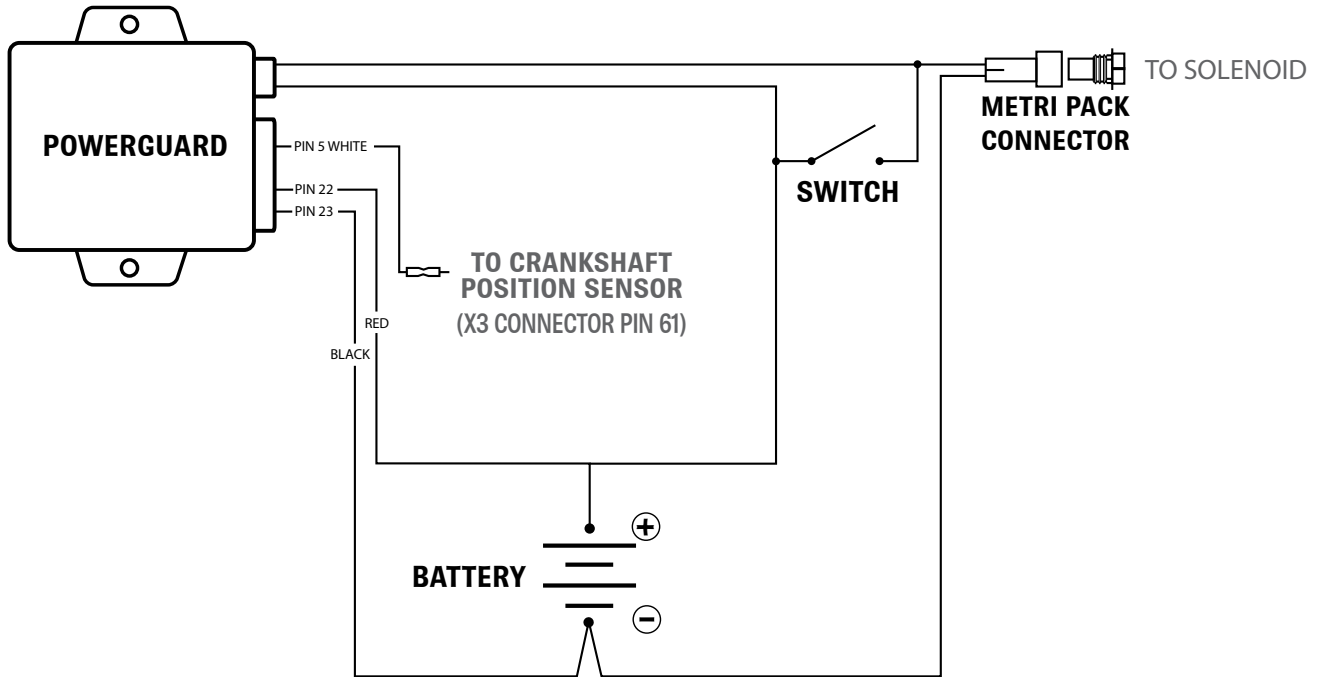

**CUSTOMER SERVICE HOURS**

MONDAY TO FRIDAY FROM 6:00 AM TO 4:30 PM PST

**BUSINESS HOURS OF OPERATION**

MONDAY TO FRIDAY FROM 7:30 AM TO 4:00 PM PST

**CORPORATE HEADQUARTERS / R&D CENTER**

19594 96TH AVENUE  
SURREY, BRITISH COLUMBIA



ISO 9001  
QMI-SAI Global