

Installation Manual

VERSION
FRANÇAISE



AIR SUSPENSION KIT

Chevrolet Silverado/GMC Sierra 1500 (2WD/4WD) †*

† For short (69.3") & medium (78.7") truck bed lengths (Not for 97.6" Truck Beds)
Will not fit vehicles equipped with magneride.

Use the most advanced air springs on the market to eliminate your vehicle's sag, sway and bottoming out. This heavy duty air suspension kit levels your truck's stance while providing added support for an overall smooth and safe ride.

* See application guide for proper fitment.

L6360_REV8_02.21.2024

Thank you and congratulations on the purchase of an Air Suspension kit. Please read the entire manual prior to starting the installation to ensure you can complete it once started.

IMPORTANT

This air suspension kit will not increase the GVWR (*Gross Vehicle Weight Rating*), as the GVWR is determined by the vehicle manufacturer. **Do not exceed the maximum capacity listed by the vehicle manufacturer.**

For safe and proper operation of the vehicle, never exceed a maximum of 100PSI in the air springs. Staying under the pressure limit will ensure maximum air spring life. **Failure in doing so may result in damage to your vehicle and/or a void warranty.**

SAFETY WARNINGS!

! Please read and abide the instructions found in this manual, paying close attention to the helpful, cautionary or dangerous warning icons highlighting important safety recommendations and maintenance suggestions throughout this manual.

+ **HELPFUL INSTALL TIP**
Additional information that could potentially make the job a little easier.

! **PLEASE USE CAUTION**
Unsafe practices could result in damage to you or your vehicle, or others.

! **DANGER WARNING**
Hazards which could result in severe personal injury or death.

! Serious personal injury or death may result from an air spring failure or accident due to improper installation or air spring pressure operation or maintenance.

! Inflating an unsecured air spring is dangerous. If it bursts, it could be hurled into the air with explosive force resulting in serious personal injury or death. Never inflate an air spring unless it is secured to the vehicle.

! Removing and replacing air springs can be dangerous. This is only a job for a qualified service professional. Never perform air spring service procedures without proper training, tools, and equipment.

BEFORE STARTING THE INSTALLATION

- Ensure the application information is correct for the make, model and year of the vehicle you are installing the kit on.
 - Some vehicles are equipped with a rear wheel brake proportioning valve. Check with the manufacturer before installing the air spring kit, as it may affect braking performance.
 - It is recommended to use a good quality anti-seize on all fasteners. This will reduce the chance of corrosion on the fasteners and will help facilitate removal, if required at a later date.
- !** **PLEASE NOTE:** This kit contains push-to-connect fittings; using scissors or wire cutters to cut the nylon air line will distort the line and cause the connection to leak. The air line must be cut off squarely with the hose cutter provided in this kit, or a sharp utility knife. **Failure to do so may void the warranty.**



WARNING: This product can expose you to the chemical Hexavalent Chromate, which is known to the State of California to cause cancer and birth defects or other reproductive harm. **For more information go to www.P65Warnings.ca.gov**

KIT CONTENTS

Please confirm the items below are provided in your kit before starting the installation. Reference the kit explosion diagram on the following page for part assembly.

HEAVY DUTY KITS		QTY	PART #
A*	Double Convoluted Spring	2	HP10000

HEAVY DUTY JOUNCE BUMPER KITS		QTY	PART #
A*	Double Convoluted Spring w/ Jounce Bumper	2	HP10000J

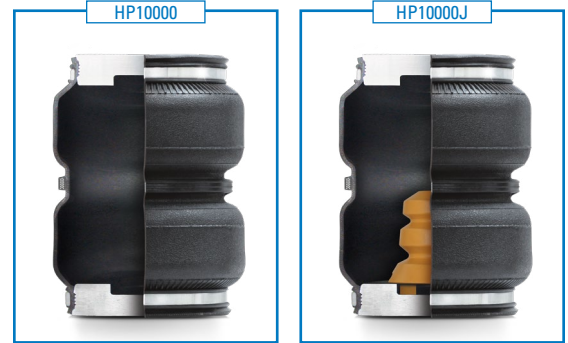

KIT CONTENTS		QTY	PART #
B	Upper Bracket Driver Side	1	HP1432
C	Upper Bracket Passenger Side	1	HP1431
D	Lower Bracket	2	HP1433
E	J Clamp	4	HP1434
F1	Capscrew, Countersunk	8	HP1008
F2	Bolt 3/8 x 1 1/2 NC	2	C18018
F3	Flat Washer 3/8"	2	C18006
F4	Flat washer 3/8" SAE	14	C653
F6	Screw Hex Cap 3/8"-16	4	HP1416
F7	Nut Nyloc 3/8"-16	10	HP1000
F8	U-Bolt	2	HP1331
F9	Airline Hose Assembly	1	HP1344
F10	Bolt, Self-Tapping 3	2	HP1078
F11	Cable Clamp 5/8"	2	HP1435
F12	Cable Clamp 1"	1	HP1436
F14	Bolt Leader Tool	1	HP1440
F15	Heat Shield	1	HP0012
F16	Worm Gear Ring Clamp (2 1/2" - 4 1/2")	2	HP1001
F17	Worm Gear Ring Clamp (4 1/2" - 6 1/2")	2	HP1377
H1	Fitting, Brass, Push	2	HP1099
H2	Tywrap	6	C11618
H3	Roll Plate	4	HP10054

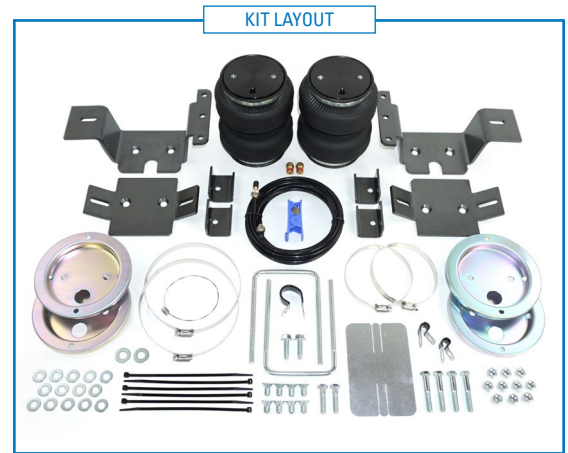

REQUIRED TOOLS

- Hoist or Floor Jack
- Safety Stands
- Safety Glasses
- Torque Wrench
- Standard Combination Wrenches
- 7/32" Hex Allen Wrench
- Ratchet
- Metric & Standard Sockets
- Hose Cutter (included) or Sharp Utility Knife
- Pipe Thread Sealant
- Spray Bottle with Dish Soap/Water
- Air Compressor/Compressed Air Source (to test/fill air springs)

KIT EXPLOSION DIAGRAM

PASSENGER SIDE ASSEMBLY SHOWN

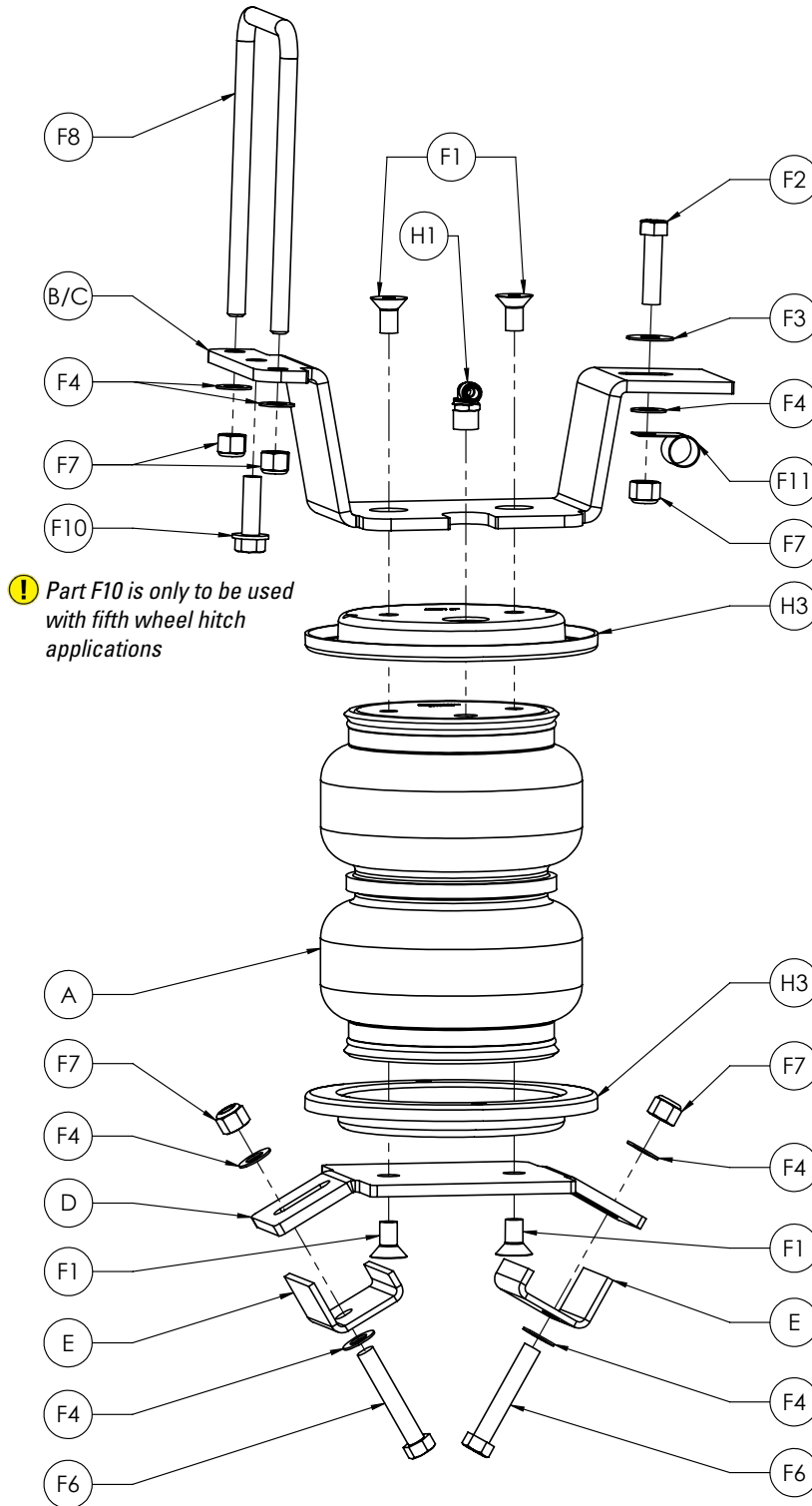
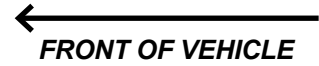

INSTALLATION INSTRUCTIONS**1 RAISE THE REAR AXLE**

- Remove any unnecessary weight from the vehicle to attain normal ride height. This is important for correct initial air spring setup and adjustment.
- Park the vehicle on a level surface.
- Record the vehicle's normal ride height, which is the distance between the center of the axle and the horizontal wheel well flange. Ensure both sides are the same before raising the vehicle.
- Raise the rear axle high enough to remove both rear wheels and attain a comfortable working height.
- Place two jack stands under the axle, as shown in figure (1A-1B)
- Lower the floor jack until the vehicle axle is supported by the jack stands.
- Ensure the normal ride height measurement recorded earlier is the same. Adjust if necessary before proceeding.
- Once the rear axle is raised correctly, remove the rear wheels.

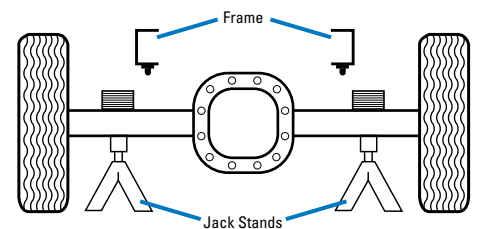
**1A****1B**

2 REMOVE THE LINE HOLDER

- Remove and discard the ABS line holder located on the left side (driver's side) of the frame rail, on the inside of the frame, just forward of the axle
- Pull the ABS line holders out from the frame and remove from the ABS line. They are attached to the bottom of the frame, behind the axle, on the left (driver's) and right (passenger's) hand side. (See picture 2C)
- Use a small screw driver to unhook the clamp from the line and remove it. Discard the clamp since it will no longer be used.
- Install the small cable clamps facing up, onto the ABS line where the stock line holders were attached with the hole facing forward on the line. Do this on both sides. (see picture 2D)
- Leave the ABS line hanging loose for later installation.

! **CAUTION:** BECAUSE THE EMERGENCY BRAKE CABLE IS IN A LOCATION THAT MAKES IT POSSIBLE TO RUB A HOLE IN THE SIDE OF THE AIR SPRING, IT WILL BE NECESSARY TO RELOCATE IT AWAY FROM THE AREA WHERE THE AIR SPRING IS INSTALLED.

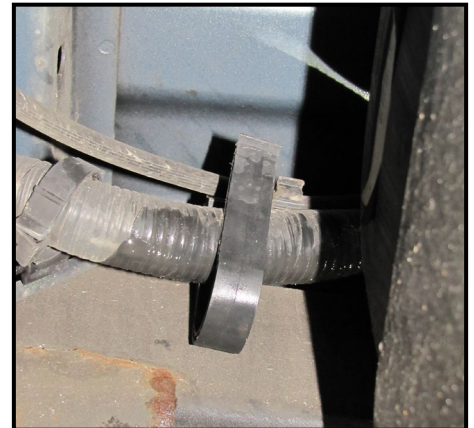

2A



2B



2C



2D

3 REMOVE THE JOUNCE BUMPERS

- Remove the jounce bumpers from under the frame rails on both sides. (See picture 3A)
- Remove the jounce bumpers by unbolting them from the jounce bumper mounting cups welded to the frame, using a 10 mm socket.
- Pull or pry the jounce bumpers out of the cup with a screw driver once the bolt has been removed.

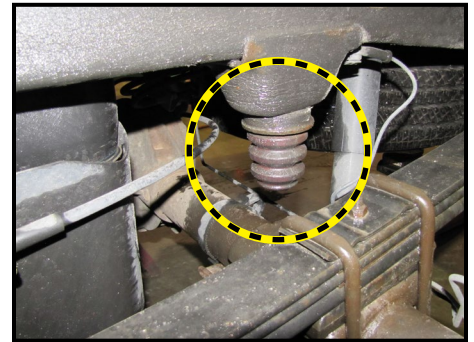

3A

4 ASSEMBLING THE AIR SPRING

- Set a roll plate (H3) over the top of the air spring (See photo 4A).
- NOTE:** The rounded edge of the roll plate (H3) will be towards the bellows so that the bellows is seated inside both roll plates.
- Install the swivel fitting (H1) into the top of the air spring finger tight plus one and a half turns.
 - Install the upper bracket (see photo 4B) onto the air spring using four flat head screws (F1). Torque to no more than 20 ft-lbs.
 - Install the lower bracket (see photo 4C) onto the bottom of the air spring using the flat head screws (F1). Torque to no more than 20 ft-lbs.



4A

- ⚠ **NOTE:** The lower bracket has one corner cut off, this side of the bracket must point to the opposite side of the air fitting on the air spring assembly.

The figure 4C-4D below shows both left and right hand assemblies ready for installation.



4B



4C



4D

5 INSTALLING THE AIR SPRING ASSEMBLIES

- Install a large flat washer (F3) over the hex head bolt (F2) and thread the bolt onto the supplied wire to create a leader tool.
- Insert the bolt and washer through the slot on the side of the frame and through the slot on the bottom of the frame where the ABS line holder was removed. Repeat on the other side.

+ **NOTE:** *The fittings on both air springs will be facing inboard.*

- While raising the assembly, line up the bolt previously installed with the back hole on the bracket. Set the new ABS line holder over the bolt once the upper bracket is in place and cap with a flat washer (F4) and nylon locknut (F7). Leave loose at this time.

There are two ways to attach the front side of the upper bracket depending on whether you have a 5th wheel bracket running alongside of the frame or not.

FOR VEHICLES WITHOUT A 5TH WHEEL BRACKET ALONG THE SIDE OF THE FRAME:

- Set the U-bolt (F8) over the frame and through the holes in the upper bracket forward of the axle.

! **CAUTION:** *DO NOT PINCH THE LINES ON THE LEFT (DRIVER) SIDE FRAME RAIL.*

- Cap with flat washers (F4) and nylon locknut (F7). Position the front upper bracket onto the frame rail so the center hole is in the middle of the frame and there is sufficient clearance between the fitting and the stock jounce bumper cup.
- Torque the U-bolts to 10 ft-lbs. Repeat on the other side.



5A

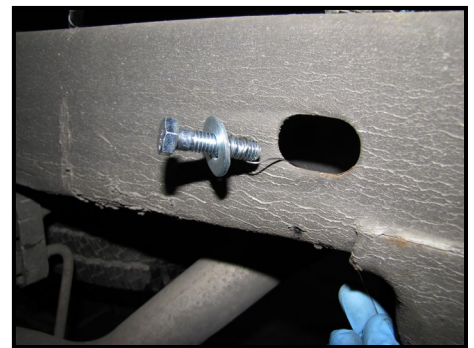

5B



5C

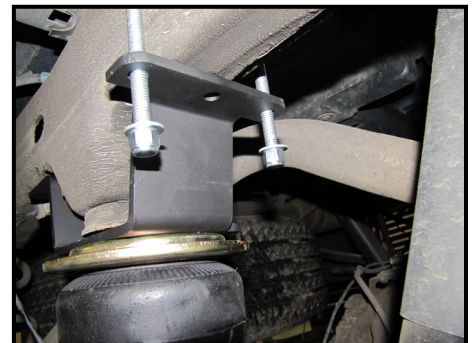

5D

5 INSTALLING THE AIR SPRING ASSEMBLIES CONTINUED

FOR VEHICLES WITH A 5TH WHEEL HITCH BRACKET THAT RUNS ALONGSIDE THE FRAME:

- Center the upper bracket in the middle of the frame rail, make sure there is sufficient clearance between the fitting and the stock jounce bumper cup, and drill a $\frac{5}{16}$ " hole in the frame using the center hole in the front side of the upper bracket as a template. Install the Washer Head Self Tapping Screw (F10) in the hole.
 - Torque to 15 ft-lbs. Repeat on the other side.
 - Finish the upper bracket installation by torquing the rear bolt to 15 ft-lbs.
- + NOTE:** use a $\frac{1}{4}$ " ratchet with an extension and universal joint with a $\frac{9}{16}$ " socket through the hole in the side of the frame to hold the rear mounting bolt for torquing.
- + NOTE:** Long box models may require a short extension.
- + NOTE:** If the 5th wheel bracket sits below the frame rail, trim the upper bracket and use the center bolt to snug it to the frame. Bolting the opposite side first will help to ensure alignment. U-Bolts will not be used in this application.

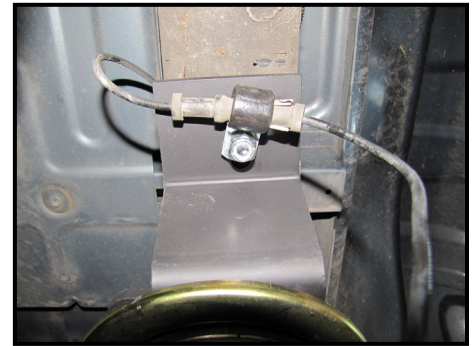

5E

AIR SPRING ALIGNMENT

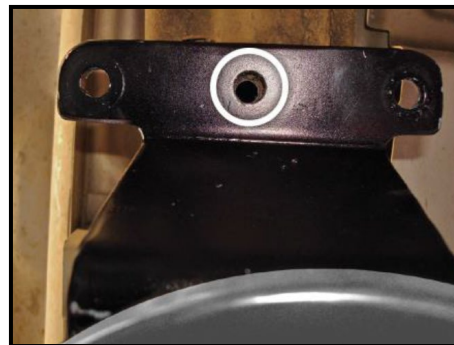
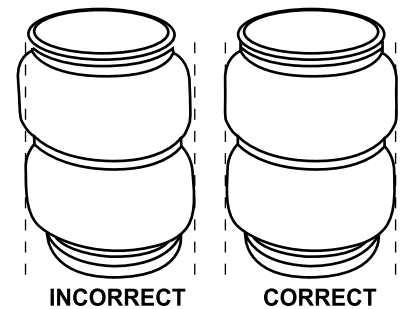

5F



5G



5H



5I

6 LOWER BRACKET INSTALLATION

Push the lower bracket (D) forward or back to center it over the jounce bumper strike plate. Insert a Hex Head Bolt (F6) through a Flat Washer (F4) and J-clamp (E). Install the J-clamp with the short end under the Jounce Bumper Strike Plate with the bolt through the lower bracket. Cap with a Flat Washer (F4) and Nylon Locknut (F7). Do this on the front and rear of the lower bracket and evenly torque both sides to 10 ft-lbs keeping the lower bracket centered over the jounce bumper strike plate on the axle. Repeat on the other side.

- ⊕ **NOTE:** It may be necessary on some models to slightly pull down the hard brake line on the rear right (passenger side) in order to install the lower bracket mounting hardware.



6A

7 EMERGENCY BRAKE CABLE MODIFICATIONS

- It will be necessary to re-locate the emergency brake cable that is held by a bracket on the top of the axle center carrier section of the rear end.
- Remove the top bolt that is holding the emergency brake cable bracket onto the center section of the rear end.
- Remove the bracket from the emergency brake cable and discard it.
- Install the large cable clamp over the emergency brake cable facing the rear with the hole down and attach to the rear end using the stock bolt previously removed.
- Bend the large cable clamp slightly to obtain clearance of the hard brake lines. Mounted on top of the axle.
- Insert the emergency brake cable into the large cable clamp.



7A



7B

8 INSTALL THE HEAT SHIELD

- Bend the tabs on the heat shield (F15) so there will be the necessary 1/2" dead space between the heat shield and the exhaust pipe when the heat shield is attached.
 - Attach the heat shield (F15) to the exhaust pipe on the passenger side using two hose clamps (F16/F17). Each hose clamp holds a tab against the exhaust pipe. Make sure the heat shield is facing toward the air spring.
- ⊕ **NOTE:** The small worm gear clamps (F16) are intended to be used with an exhaust that is between 2.5-4.5" in diameter. The larger worm gear clamps (F17) are intended to be used with an exhaust that is between 4.5-6.5" in diameter.



7C

INSTALL AIR LINE

Two fill valves are provided in this kit. The most common place to install them is in place of the license plate fasteners. Alternatively, two 5/16" holes can be drilled in a location of your choosing.

Cut the air line assembly into two equal lengths with the hose cutter provided in this kit or a sharp utility knife.

! **PLEASE NOTE:** *This kit contains push-to-connect fittings; using scissors or wire cutters to cut the nylon air line will distort the line and cause the connection to leak. The air line must be cut off squarely with a hose cutter or a sharp utility knife.*

Install one air line at a time starting at the fill valve location. Place a 5/16" nut on the air valve. Leave enough of the inflation valve in front of the nut to extend through the hole, install a flat washer, and 5/16" nut and cap (reference Figure A for assembly). There should be enough valve exposed after installation – approximately 1/2" – to easily apply a pressure gauge or an air chuck.

Route the air line back to the NPT fitting on the air spring, then cut the hose to length. Moisten the end of the air line prior to inserting it into the fitting and push it in until it stops.

Repeat with the other fill valve.

Secure the air lines using the provided tie-straps, away from any moving items and heat sources.

CHECK SYSTEM FOR LEAKS

Inflate both air springs to 90 psi and then use a mixture of dish soap and water on all air line connections to detect any air leaks. Large, expanding bubbles indicate a leak (as shown in Figure B).

Repair as necessary and retest.

Inflate air springs to a predetermined value and on following day recheck pressure. If one or both of air springs have lost pressure, an air leak is present.

! **Leak must be repaired, and then retested until no leaks exist.**

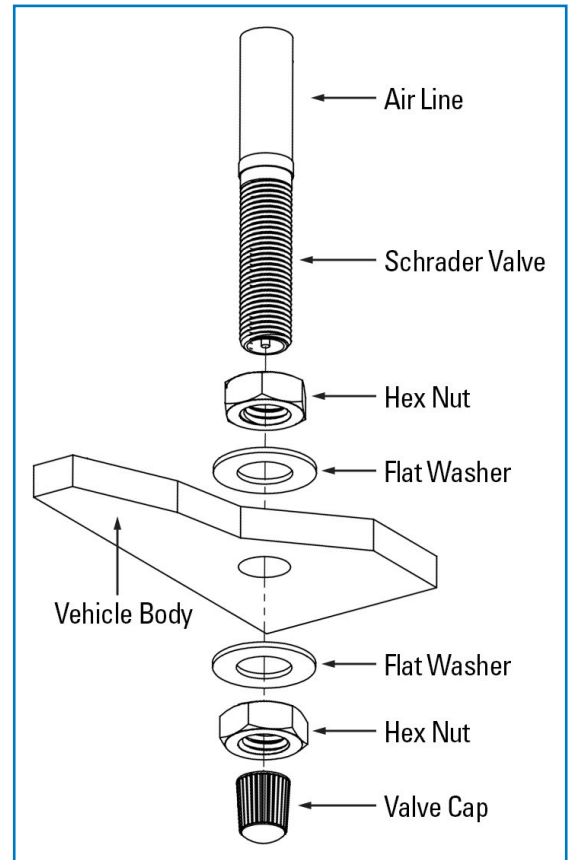

A

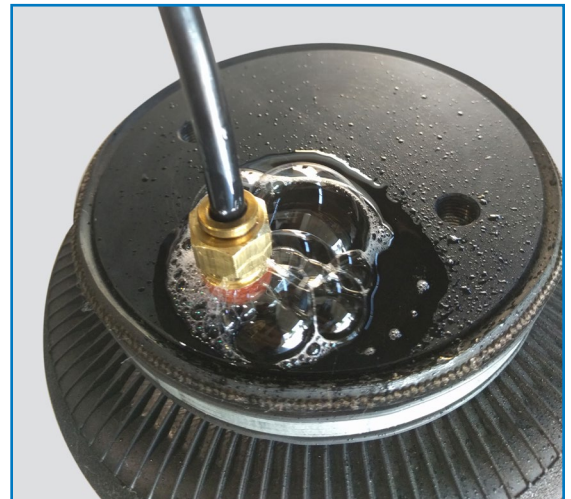

*Air Spring & NPT Air Fitting may differ between kits

B

CONGRATULATIONS! You have completed the install

After Installation continues on the following page.

Thank you again, and congratulations on the installation of your Air Suspension kit.

AFTER COMPLETING THE INSTALLATION

- The air spring must have clearance between itself and the surrounding components to prevent any contact when spring is inflated or compressed. Trimming off excess bolt length may also be required to ensure no contact with the spring or other suspension components can be made once installed.
- If removed, re-install the wheels and torque fasteners to the manufacturer's specifications. Re-torque all fasteners after the first 500 miles of driving.

OPERATING YOUR VEHICLE WITH AIR SUSPENSION

Air springs have minimum and maximum recommended pressure requirements:

PART #	SPRING STYLE	SPRING TYPE	MIN PSI	MAX PSI
HP10189	In-Coil	STANDARD DUTY	5 PSI	70 PSI
HP10560		STANDARD DUTY		
HP10001	Sleeve Style	STANDARD DUTY	10 PSI	100 PSI
HP10173		STANDARD DUTY		
HP10199		STANDARD DUTY		
HP10083	Single Convoluted	HEAVY DUTY	5 PSI	100 PSI
HP10083J		HEAVY DUTY with JOUNCE BUMPER	0 PSI* / 5 PSI	100 PSI
HP10000	Double Convoluted	HEAVY DUTY	5 PSI	100 PSI
HP10000J		HEAVY DUTY with JOUNCE BUMPER	0 PSI* / 5 PSI	100 PSI
HP10068	Large Double Convoluted	HEAVY DUTY	5 PSI	100 PSI
HP10438	Double Convoluted	EXTREME DUTY	5 PSI	100 PSI
HP10438J		EXTREME DUTY with JOUNCE BUMPER	0 PSI* / 5 PSI	100 PSI

* Springs with a jounce bumper can be run at zero PSI when vehicle is unloaded only

For safe and proper operation, never operate the vehicle over the maximum listed PSI in the air springs. Staying under the pressure limit will ensure maximum air spring life. **Failure in doing so may result in damage to your vehicle and/or a void warranty.**

! *It is recommended to check the air pressure in your air springs daily for first couple of days to ensure a leak has not developed.*

Air springs are designed to maintain the vehicle's stock ride height with a load. Do not use the air springs as a means to lift vehicle with no load. This will result in a harsh ride.

SERVICING YOUR VEHICLE WITH AIR SUSPENSION

When lifting the vehicle with a floor jack or hoist on the frame, never allow the air spring to limit the travel of the axle. Try to always jack the vehicle on the axle. Suspending the axle with the air spring limiting the axle travel will damage the air spring and void the air spring warranty.

WARRANTY

See additional warranty included with this kit for details.

