

Installation Manual

PH2 POWERHALT
AIR INTAKE EMERGENCY SHUT-OFF VALVE



C50207 AIR INTAKE SHUT-OFF VALVES

APPLICATION
2011 - 2016 FORD 6.7L POWERSTROKE

800.663.0096

www.powerhalt.com



Thank you for your purchase of a PowerHalt Air Intake Emergency Shut-Off Valve by Pacbrake. Please read the entire manual to ensure you can complete the installation once started.

Should you have any issues during the installation, please call technical support.

A PowerHalt Technical Representative can be reached Monday-Friday 6:00-4:30 (PST) at 800.663.0096

INSTALLATION REQUIREMENTS & RECOMMENDATIONS:

- A 1" clearance is required from the valve to any other components.
- Maximum air temperature at the valve should not exceed 150°C.
- All hoses, adapters, and fittings must be suitable for the vibration of the engine application, and of reinforced type. *If unsure of your vibration requirement, contact Pacbrake.
- Flexible hose gaps should be kept to a minimum and the overall pipe quality and integrity from the shut-off valve to the intake manifold should be confirmed.

NOTE: - Failure to ensure this may result in hose collapse during valve activation and possible system leaks, preventing engine shutdown

- If an air intake flame trap is used, the valve must be installed upstream of the trap.
- Crankcase breather connections in the intake system between the valve and engine (or in engine intake parts) must be sealed and replaced by an external breather.

Please ensure that you have all the parts listed in this kit **before** you start the installation.

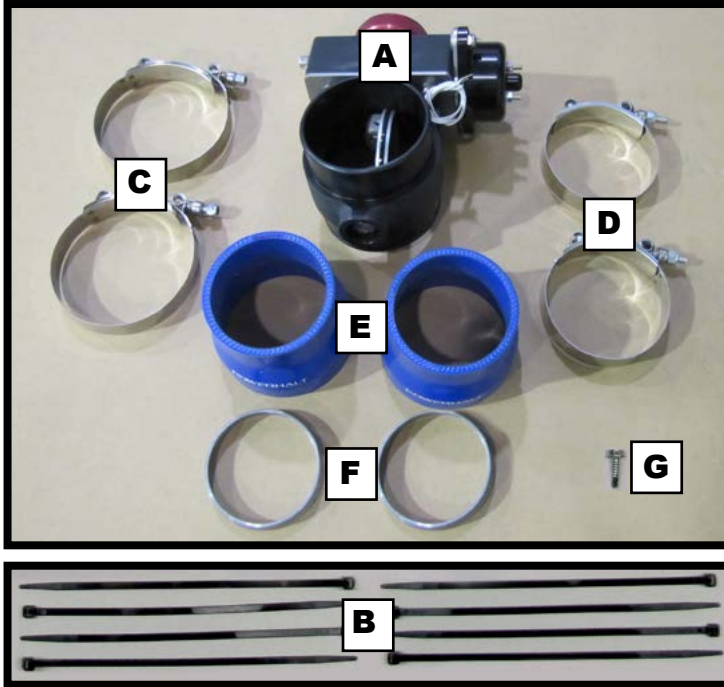

KIT CONTENTS

- A** Shut-Off Valve (1)
- B** Tie Straps
- C** 3" Clamps (2)
- D** 3½" Clamps (2)
- E** 3½" - 3" Silicone Reducer (2)
- F** Bead Ring (2)
- G** Self Tapping Screw (1)
- H** Harness
- I** Washer
- J** Nut
- K** Switch
- L** Switch Identification Plate
- M** Switch Cover
- N** Relay

REQUIRED TOOLS

- Drill
- 1/2" Unibit
- Ratchet with 7/16", 1/2" and 10mm Deep Sockets
(a 14" extension is ideal)
- Soldering Iron
- Wire Strippers & Crimpers
- Electrical Tape
- Cut-Off Saw / Angle Grinder
- Welder

COMPLETED VALVE ASSEMBLY FOR REFERENCE



- 1** | Open the hood.
Disconnect both batteries

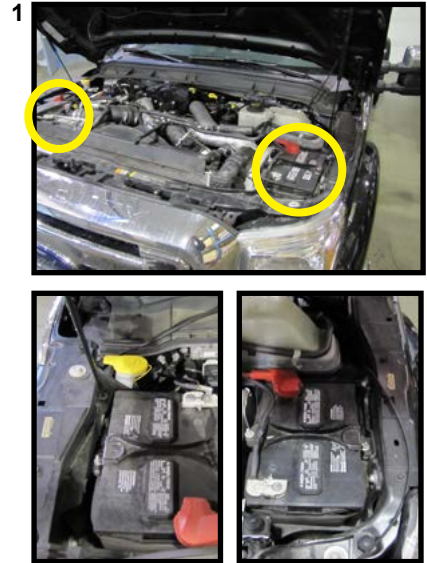

- 2** | **RELAY INSTALLATION:**
Obtain the provided wiring harness (2A).
Mount the relay receptacle (2B) in a convenient location (typically on the driver's side of the engine compartment), using a self-tapping screw or the provided tie straps.

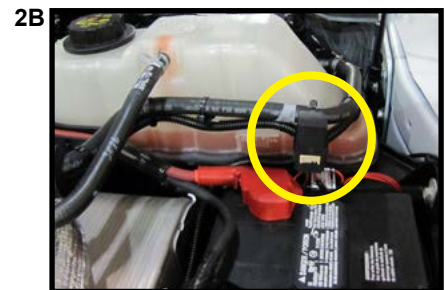

- 3** | **SWITCH LOCATION:**
Locate the desired location for the activation switch in your cab.

NOTE:

- Activation switch should be as close to driver's side door as possible to allow for shutdown when standing outside of the vehicle
- Consider the dash construction, as the switch requires a single dash wall for install unless the double wall is modified
- **DO NOT ACTIVATE THE MANUAL SWITCH FOR MORE THAN 10 SECONDS.**
Damage to the solenoid may occur



4 SWITCH INSTALLATION:

Drill a ½" hole in the desired location. Then, install the PowerHalt switch, switch plate, and red switch guard as shown (4A).

Tighten the nut to secure the switch in place.

NOTE: If the dash cannot accept the switch nameplate, use the toggle sticker and install onto the switch cover as shown.

Route the green and black wire to the switch, and cover the wires with the provided loom. Crimp one of the red spade terminals to each wire and connect the wires to the switch (4B), as per the wiring diagram on page 11.

NOTE: Ensure the wiring harness routing is secured with provided tie straps and away from any moving parts or high heat sources.

5 BATTERY CONNECTION:

Route the two green and one red fused wire with ring terminals to the driver's side battery location.

Connect the green wires to the negative terminal.

Connect the red fused wire to the positive terminal.

NOTE: Ensure the wiring harness routing is secured with provided tie straps and away from any moving parts or high heat sources.

6 VALVE INSTALLATION PREPARATION:

Remove the driver's side charge air cooler (CAC) pipe (6A) using a flat screwdriver to release the spring clips on the turbo intake (pic 6B), and 7/16" deep well socket with ratchet to loosen the clamp (pic 6C) which releases the pipe from the charge air cooler.

DASH →

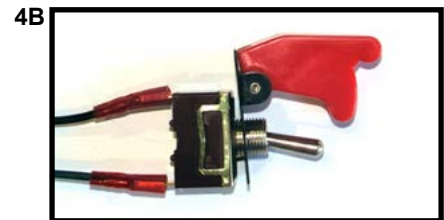

7 Once the pipe is removed, mark each end of the pipe with the letters 'A' and 'B'. 'A' will be your turbo side, and 'B' will be the CAC side.

The first cut can be made at 4¼" from the factory pipe benders grip start on the CAC side. NOTE: the grip start is approximately 3" from the end of the silicone boot, as per image 7A.

Then make a second cut from the grip start at ¼".

NOTE: Ensure all the cuts are straight.

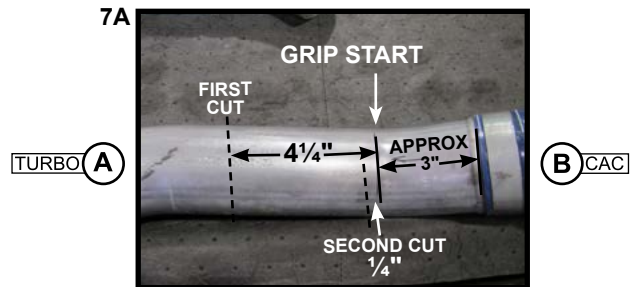
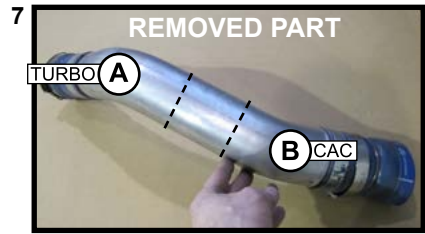

Cut pipes should look like this:

8 Notch the ends of each cut pipe in 3 equal places with an angle grinder or cut off saw, as shown in pic 8A.

Attach the machined bead ring to the end of each cut pipe and tack weld into place by welding in the newly created notch (pics 8B and 8C).

Make sure that full weld penetration is achieved.

Then file smooth any burrs or snags from the welding.

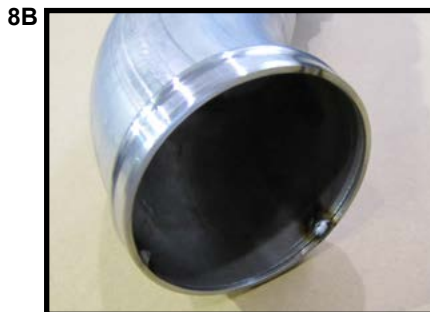

- 9** | Attach the 3.0-3.5" silicone reducers to each end of the cut pipes. Slide the reducers over the machined beads far enough that the 3" band clamp grips fully on the reducer with an additional 1/16", as shown in images 9A and 9B.

Torque to 75 in-lbs.

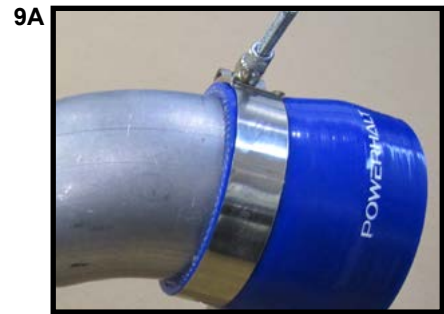

- 10** | Attach the turbo side of the pipe onto the turbo outlet first. Push it on hard enough that the retainer clips into place.



- 11** Loosely install one 3.5" band clamp over the reducer end. Install the PowerHalt, making note of the flow direction. The arrow should be pointing away from the turbo and towards the intercooler.

NOTE: The arrow is shown on the body of the valve, on the opposite side of the electric solenoid actuator.

Tighten the band clamp hand tight.

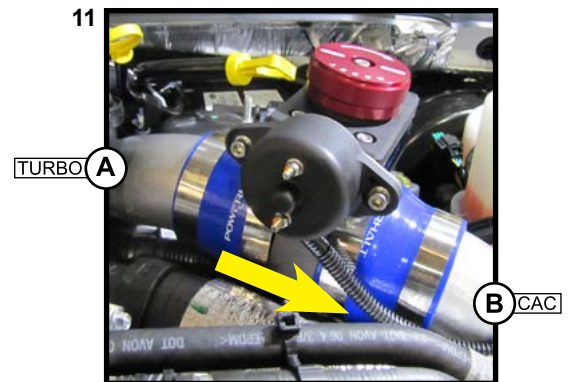

- 12** Place the second 3.5" clamp over the silicone reducer on the intercooler side of the CAC pipe.

Install the pipe labelled 'B' (CAC end) onto the PowerHalt valve as shown in pic 12A and hand tighten the clamp.

Connect the other end to the intercooler and snug up the factory clamp tight (pic 12B).



- 13** Rotate the pipe and the PowerHalt valve into position so that they are not rubbing or touching any other engine components. The reset knob should be somewhat horizontal with the top of the engine.

Torque all clamps to 75 in-lbs.

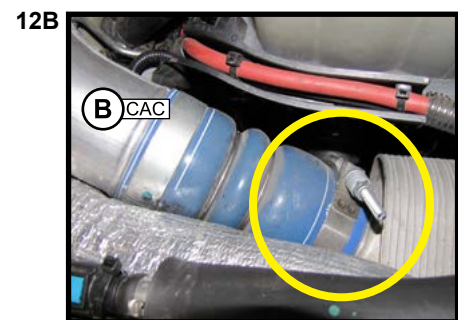

- 13** Connect the metri pack connector of the harness to the mating connector on the PowerHalt.

NOTE: Ensure the wiring harness routing is secured with provided tie straps and away from any moving parts or high heat sources

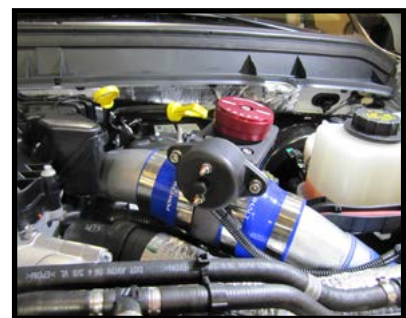

- 14** Reconnect the batteries.

WINDOW DECAL

Install the window decal included in your kit to the lower corner of the inside of your windshield so that it is legible to those on the outside.

POST INSTALLATION TESTING OF YOUR POWERHALT SHUT-OFF VALVE

Once the installation is complete, ensuring all the steps, schematics and recommendations have been followed, it is time to test your system.

1. Activate the manual switch (no engine running).
NOTE: DO NOT ACTIVATE THE MANUAL SWITCH FOR MORE THAN 10 SECONDS. Damage to the solenoid may occur
2. View valve and confirm valve has tripped. The reset knob should be in the tripped position. This will have the line direction on the reset knob facing 90° from air flow direction.



VALVE CLOSED (TRIPPED)



VALVE OPEN (RUN POSITION)

3. Reset the valve.
4. Start the engine and run at low RPM (preferably at idle).
5. Activate the PowerHalt shut-off valve by pushing the manual switch in an upward direction. The engine should stop within a few seconds.
 - If the engine does not shutdown in the specified time please check all intake piping and hoses for leaks between the valve and intake system.
 - If the system is leak-free and your valve still does not shut down the engine, please consult a PowerHalt Service Representative for support.
6. Once the engine stops, wait 30 seconds, then reset the valve by turning the red reset knob clockwise to the open "Run" position with knob arrow in line with air flow direction.

VALVE OPERATION

Prior to running your system you must ensure that the valve is latched (clockwise) into its open position and that the above installation procedure was completed as described. It is recommended that the engine be shipped with the shut-off valve system in its active/open and ready-to-use state.

To carry out the emergency shutdown procedure, the pull cable handle must be pulled as this will shut the valve and stop the engine.

CAUTION: *No attempt to restart the engine should happen until the activation information/details are understood and the valve is confirmed to be returned back to the open "Run" position.*

NOTE: *Please reference your specific operation procedures defined by your organization for additional operation specifics/details. If you require additional recommendations on the steps to operate your shut-off valve, please reference PowerHalt's operation manual based on your application.*

VALVE MAINTENANCE

To ensure a trouble-free long life of your PowerHalt shut-off valve a scheduled maintenance procedure is mandatory. It is recommended that you follow the requirements & procedures stated below:

MONTHLY REQUIREMENTS

- Inspect all clamps, pull cables and support brackets to ensure they are in good condition and to the required torque.
- Inspect all wiring & cable runs to ensure there is no corrosion or wear.
- Inspect all hoses to ensure there are no cracks or damage.
- Activate the valve to ensure it is exercised.
See procedure below.

3 MONTH REQUIREMENT *(or at oil change interval's whichever comes first)*

- Lubricate the PH2, flap O-ring, with Parker® Super O-Lube, Part # SLUBE 884-2, or equivalent.

VALVE ACTIVATION PROCEDURE:

- 1 Run engine at low RPM (preferably at idle).
- 2 Activate the PowerHalt shut-off valve by pulling the cable handle.
The engine should stop within a few seconds.

NOTE:

- *If the engine does not shutdown in the specified time, please check all intake piping and hoses for leaks between the valve and the intake system.*
 - *If the system is leak free and your valve still does not shut down the engine, please consult PowerHalt's service representative for support.*
- 3 Once the engine stops, wait 30 seconds, then reset the valve by turning the red reset knob clockwise to the open "Run" position with knob arrow in line with air flow direction.

CAUTION: *The #1 failure mode of any valve in the market is seizing due to lack of use. As this is a safety device, it is imperative that you employ safety activation testing at a minimum of once per month.*

WIRING DIAGRAM

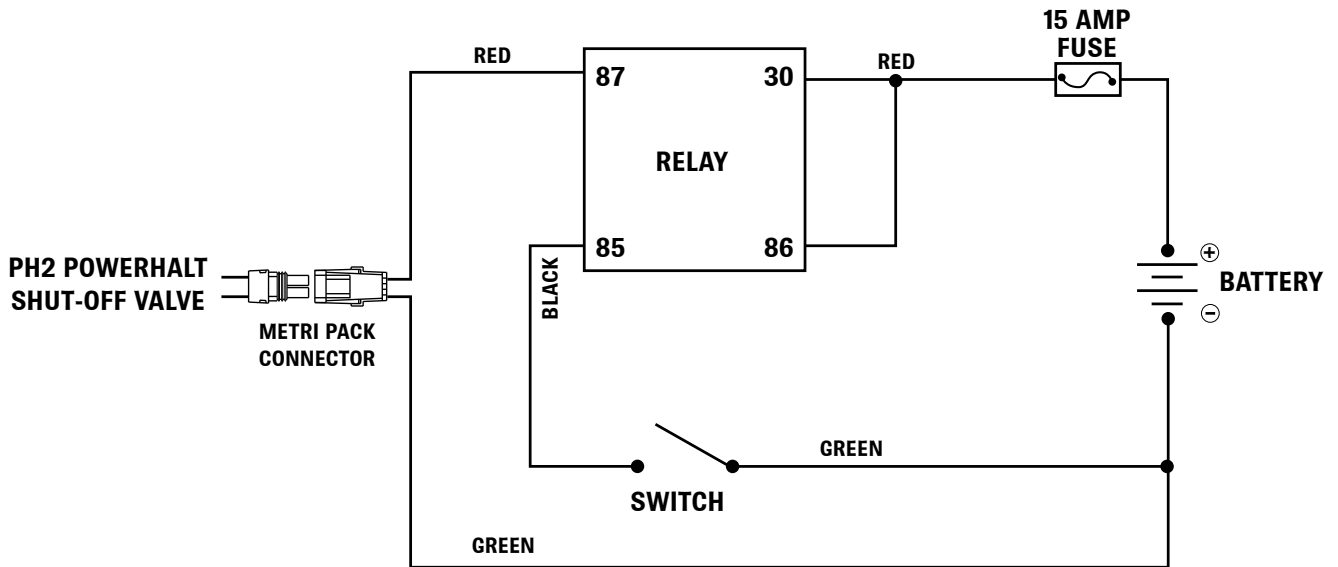

CUSTOMER SERVICE HOURS

MONDAY TO FRIDAY FROM 6:00 AM TO 4:30 PM PST

BUSINESS HOURS OF OPERATION

MONDAY TO FRIDAY FROM 7:30 AM TO 4:00 PM PST

CORPORATE HEADQUARTERS / R&D CENTER

19594 96TH AVENUE
SURREY, BRITISH COLUMBIA



ISO 9001
QMI-SAI Global